

Hund

Befestigungstechnik

Produktkatalog

www.bt-hund.de



KLAMMERTECHNIK



Klammergeräte

4

Klammern

15

BH-SET 6A



CODE	DIM.	R	€/1
------	------	---	-----

BH-SET6A 6 mm B 22,00

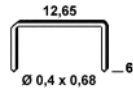

TYPE	SEITE
VS	22

PINCE 12



CODE	DIM.	R	€/1
------	------	---	-----

25RPB121 6 -12 mm B 51,00

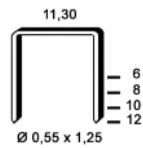

TYPE	SEITE
PB	20

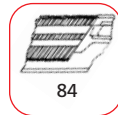
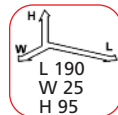

PINCE HR18



CODE	DIM.	R	€/1
------	------	---	-----

61HR18 6 mm B 64,00

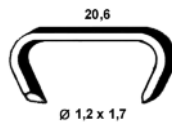

TYPE	SEITE
HR18	18

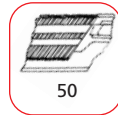
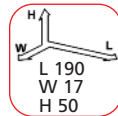

11/10 M1



CODE	DIM.	R	€/1
------	------	---	-----

133G14 4 - 10 mm B 28,00

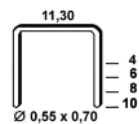

TYPE	SEITE
VX	22

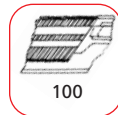
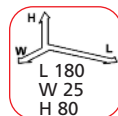

10/14 M1



CODE	DIM.	R	€/1
------	------	---	-----

133LT1 6 - 14 mm B 34,00

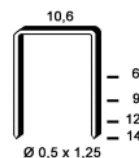

TYPE	SEITE
PF	20

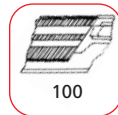
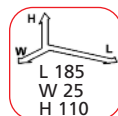

11/14 M1



CODE	DIM.	R	€/1
133LT5019	6 - 14 mm	B	36,00

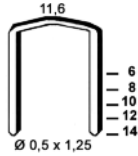

TYPE	SEITE
FB	17

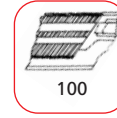
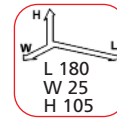

ROCAMA 16 ST50 OC (outwhere clinch)



CODE	DIM.	R	€/1
0105005	6 - 14 mm	B	77,00

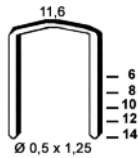

TYPE	SEITE
FB	17

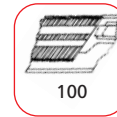
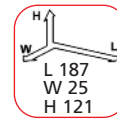

A 25



CODE	DIM.	R	€/1
20A25	12 - 14 mm	B	52,00

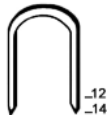

TYPE	SEITE
BC	16

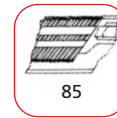
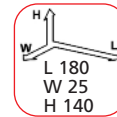

9 mm



CODE	DIM.	R	€/1
25RPF9	6 - 9 mm	B	42,00

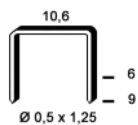

TYPE	SEITE
PF	20

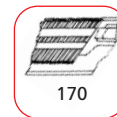
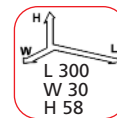

10 mm



CODE	DIM.	R	€/1
25RVZ10	4 - 10 mm	B	32,00

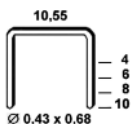

TYPE	SEITE
VZ	22

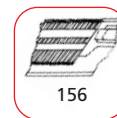
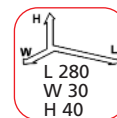

32/18 M1

manuell



CODE	DIM.	R	€/1
123218M1	15 - 18 mm	B	200,00

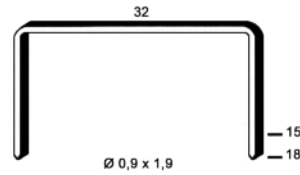

TYPE	SEITE
R	21

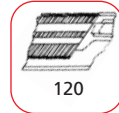
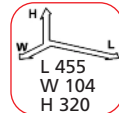

35/18 M1

manuell



CODE	DIM.	R	€/1
123518M1	16 - 19 mm	B	200,00

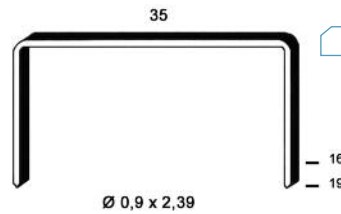

TYPE	SEITE
B	15

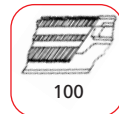
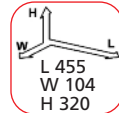

32/18 P1

pneumatisch



CODE	DIM.	R	€/1
123218P1	15 - 18 mm	B	300,00

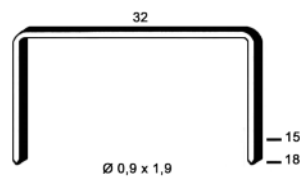

TYPE	SEITE
R	21

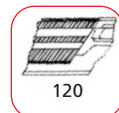
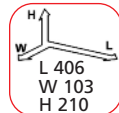

35/18 P1

pneumatisch



CODE	DIM.	R	€/1
123518P1	16 - 19 mm	B	300,00

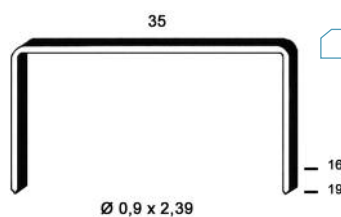

TYPE	SEITE
B	15

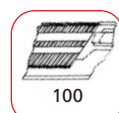
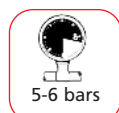
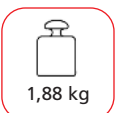
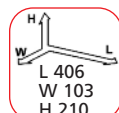

R32/18 P1

pneumatisch



CODE	DIM.	R	€/1
12R32P1	15 - 18 mm	B	350,00



TYPE	SEITE
R555	21

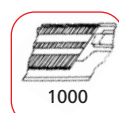
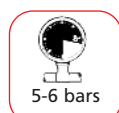
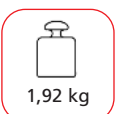
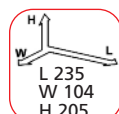

32/22 P1

pneumatisch



CODE	DIM.	R	€/1
123222P1	22 mm	B	330,00

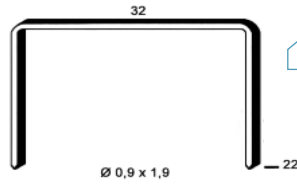

TYPE	SEITE
R	21

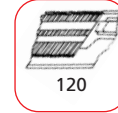
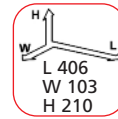

35/22 P1

pneumatisch



CODE	DIM.	R	€/1
123522P1	22 mm	B	330,00

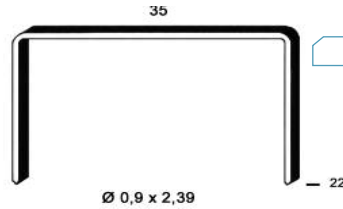

TYPE	SEITE
B	15

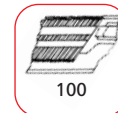
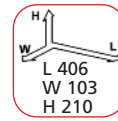

P590/38 P1

pneumatisch



CODE	DIM.	R	€/1
1559038RF	19 - 32 mm	B	1 050,00

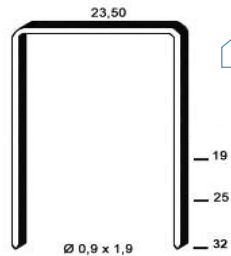

TYPE	SEITE
JK 590	18

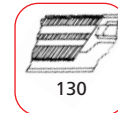
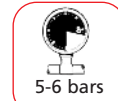
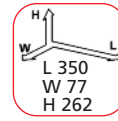

B32/22 MV2 B32/22 PV2

manuel (B3222MV2)
pneumatisch (B3222PV2)



CODE	DIM.	R	€/1
B3222MV2	15 - 22 mm	B	1 190,00
B3222PV2	15 - 22 mm	B	1 540,00

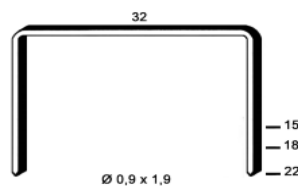

TYPE	SEITE
R	21

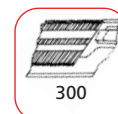
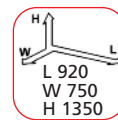

12/16 P1
12/16 PA1



automatisch

(12S8016)
(12S8016A)

CODE	DIM.	R	€/1
12S8016	4 - 16 mm	B	206,00
12S8016A	6 - 16 mm	B	340,00

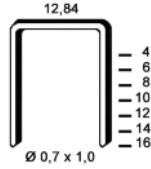

TYPE	SEITE
A	15

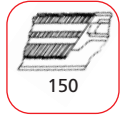
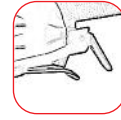
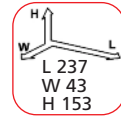

12/16 PC2



Kontakt Lamelle

(12S8016C)

CODE	DIM.	R	€/1
12S8016C	6 - 16 mm	B	280,00

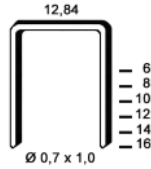

TYPE	SEITE
A	15

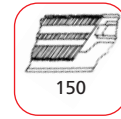
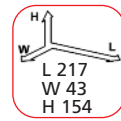

12/16 PL2



50 mm Langnase

CODE	DIM.	R	€/1
12S8016L2	6 - 16 mm	B	310,00

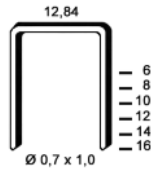

TYPE	SEITE
A	15

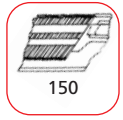
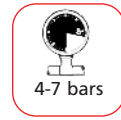
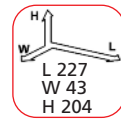

09/16 P1



CODE	DIM.	R	€/1
12S7116	4 - 16 mm	B	206,00

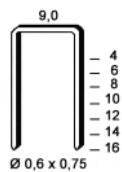

TYPE	SEITE
V	22

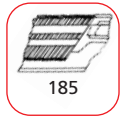
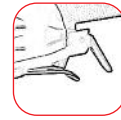
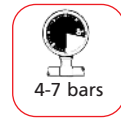
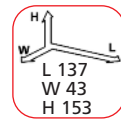

09/16 PL2

50mm Langnase



CODE	DIM.	R	€/1
12S7116L	6 - 16 mm	B	310,00

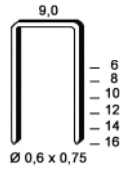

TYPE	SEITE
V	22

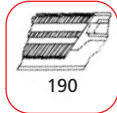
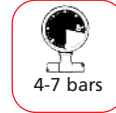
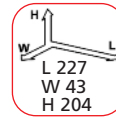

10/16 P1



CODE	DIM.	R	€/1
12140016	4 - 14 mm	B	206,00

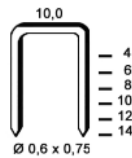

TYPE	SEITE
VF	22

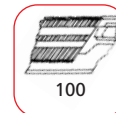
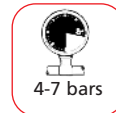
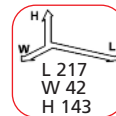

05/25 P1



CODE	DIM.	R	€/1
12S9325	10 - 25 mm	B	300,00

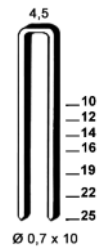

TYPE	SEITE
O	19

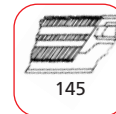
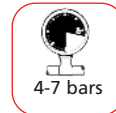
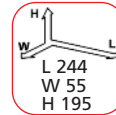

08/25 PL1

50mm Langnase



CODE	DIM.	R	€/1
12S9225L	12 - 25 mm	B	430,00

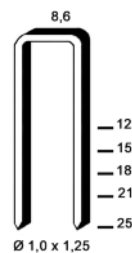

TYPE	SEITE
H	18

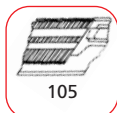
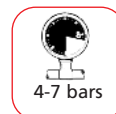
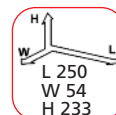

05J/32 P1



CODE	DIM.	R	€/1
12BS32PA	12 - 30 mm 15 - 32 mm	B	300,00

TYPE	SEITE	TYPE	SEITE
J	38	E	16

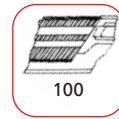
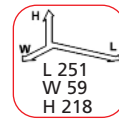
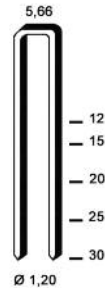
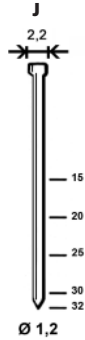

05/40 P1



CODE	DIM.	R	€/1
12S9040	12 - 40 mm	B	310,00

TYPE	SEITE
E	16
EM	17
ES	17

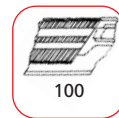
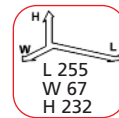
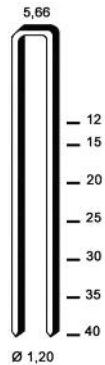

10/40 P2



CODE	DIM.	R	€/1
12S50040F1	14 - 40 mm	B	310,00

TYPE	SEITE
GB	17

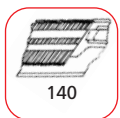
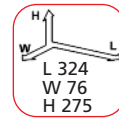
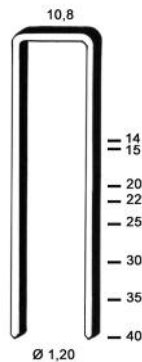

10/50 P2



CODE	DIM.	R	€/1
12S851B1	25 - 50 mm	B	590,00

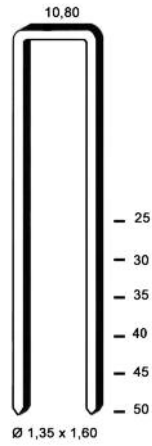

TYPE	SEITE
L	19
Z	24

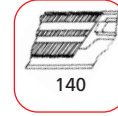
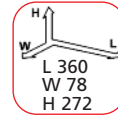

12/50 P2



CODE	DIM.	R	€/1
12S951B1	25 - 50 mm	B	590,00

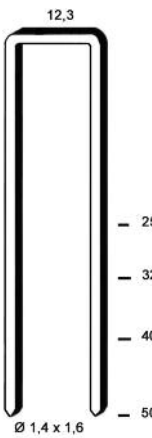

TYPE	SEITE
S	21

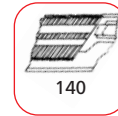
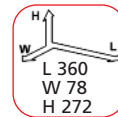

10T/65 P1



CODE	DIM.	R	€/1
12BS1416	35 - 64 mm 32 - 64 mm	B	710,00

TYPE	SEITE	TYPE	SEITE
T	40	L	19
		Q	20
		Z	24

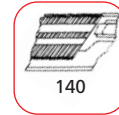
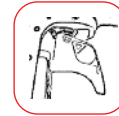
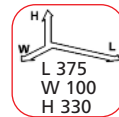
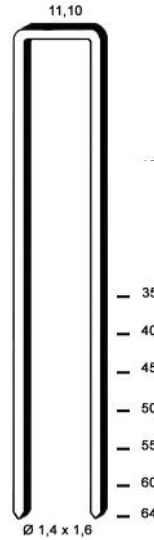
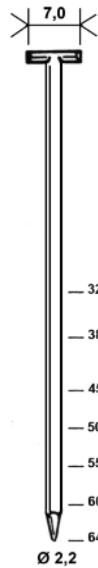

27/130 P1 27/160 P1



(12S29130)
(12S29160)

CODE	DIM.	R	€/1
12S29130	75 - 130 mm	B	1 030,00
12S29160	75 - 160 mm	B	1 180,00

TYPE	SEITE
WP	24

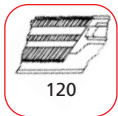
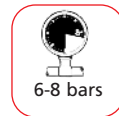
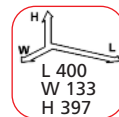
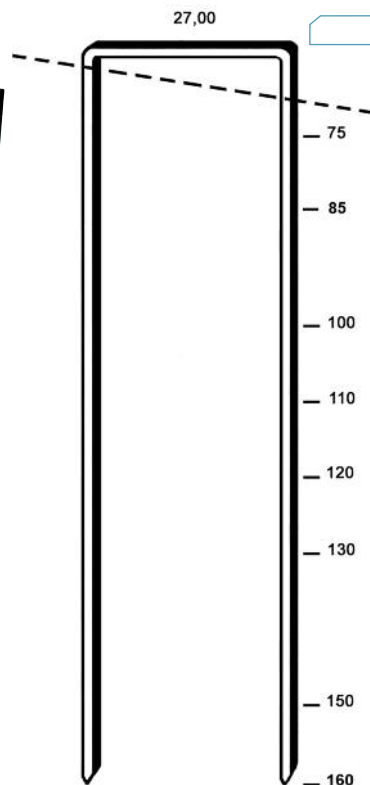

24/38 P2



CODE	DIM.	R	€/1
12S2538B1	15 - 38 mm	B	525,00

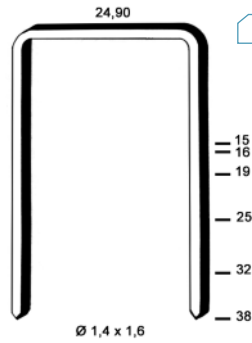

TYPE	SEITE
WC	23

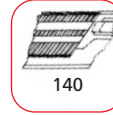
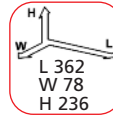

26/38 P2

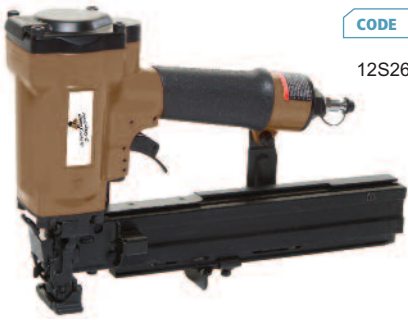

CODE	DIM.	R	€/1
12S2638B1	16 - 38 mm	B	525,00

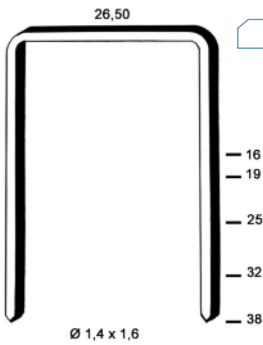

TYPE	SEITE
WS	24

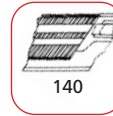
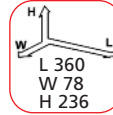

25/15 P1



CODE	DIM.	R	€/1
12SC2515	9 - 15 mm	B	535,00

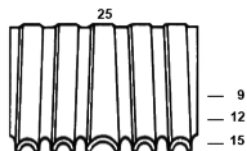

TYPE	SEITE
WN 25	23

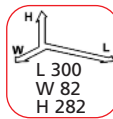

SCHIEFERHAKEN



CODE	DIM.	R	€/1
12HOOK01	80 - 120 mm	B	590,00



TYPE	SEITE
Schieferhaken	16

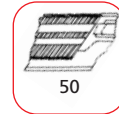
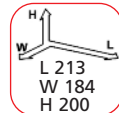

KLAMMERTECHNIK Elektrotacker

COMBI 816 SKN 12/20 E



CODE	DIM.	R	€/1
13ME80MB	6 - 16 mm 10 - 20 mm	B	270,00

TYPE	SEITE	TYPE	SEITE
J	38	A	15

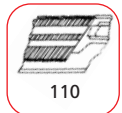
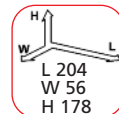
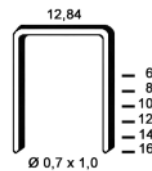
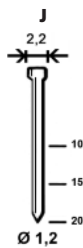

COMBI MET 32 C



CODE	DIM.	R	€/1
13MET32C	15 à 32 mm 15 à 32 mm	B	340,00

TYPE	SEITE	TYPE	SEITE
J	38	ES	17

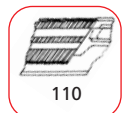
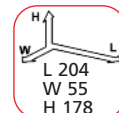
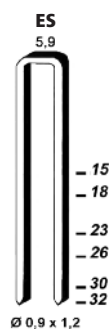

A (KL 800 - 8 - 80 - 380 - JK 680 - W130 - KO - 12 - AT)

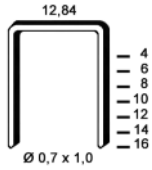

CODE	DESCRIPTION				SEITE
6A-041	A-04 verzinkt	20 000	200 000	16	8
6A-061	A-06 verzinkt	10 000	200 000	20	8/14
6A-081	A-08 verzinkt	10 000	100 000	12	8/14
6A-101	A-10 verzinkt	10 000	100 000	14	8/14
6A-121	A-12 verzinkt	10 000	100 000	15	8/14
6A-141	A-14 verzinkt	10 000	100 000	17	8/14
6A-161	A-16 verzinkt	10 000	100 000	19	8/14
6A-088	A-08 Aluminium	10 000	180 000	9	8/14
6A-148	A-14 Aluminium	6 000	108 000	7	8/14
6A-049	A-04 rostfrei	10 000	300 000	24	8
6A-069	A-06 rostfrei	10 000	180 000	16	8/14
6A-089	A-08 rostfrei	10 000	180 000	20	8/14
6A-109	A-10 rostfrei	8 000	144 000	19	8/14
6A-129	A-12 rostfrei	6 000	108 000	16	8/14
6A-149	A-14 rostfrei	6 000	108 000	19	8/14
6A-169	A-16 rostfrei	4 000	72 000	10	8/14



CODE	DESCRIPTION			SEITE
6A061BL	A-06 verzinkt Blister 1600	20	3	8/14
6A081BL	A-08 verzinkt Blister 1600	20	4	8/14
6A121BL	A-12 verzinkt Blister 1600	20	5	8/14
6A161BL	A-16 verzinkt Blister 800	20	3	8/14

AD (84 - 384 - SBNK)

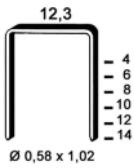

CODE	DESCRIPTION				SEITE
6AD041	AD-04 verzinkt	10 000	300 000	24	
6AD061	AD-06 verzinkt	10 000	240 000	24	
6AD081	AD-08 verzinkt	10 000	180 000	20	
6AD101	AD-10 verzinkt	10 000	140 000	18	
6AD121	AD-12 verzinkt	10 000	150 000	23	
6AD141	AD-14 verzinkt	10 000	150 000	26	

AK (KL 9000 - JK 779 - 68)

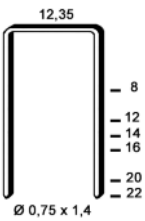

CODE	DESCRIPTION				SEITE
6AK081	AK-08 verzinkt	5 000	100 000	16	
6AK121	AK-12 verzinkt	5 000	100 000	21	
6AK141	AK-14 verzinkt	5 000	80 000	19	
6AK161	AK-16 verzinkt	5 000	80 000	21	
6AK201	AK-20 verzinkt	4 000	40 000	13	
6AK221	AK-22 verzinkt	5 000	50 000	17	
6AK089	AK-08 rostfrei A2	5 000	100 000	14	
6AK129	AK-12 rostfrei A2	5 000	100 000	23	
6AK12A4	AK-12 rostfrei A4	3 300	66 000	15	

AR-1

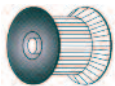

CODE	DESCRIPTION			SEITE
1451500	AR-1 5/8-15 Kupfer	24 000	24	
1451800	AR-1 3/4-18 Kupfer	24 000	24	
1452200	AR-1 3/4-22 Kupfer	24 000	24	

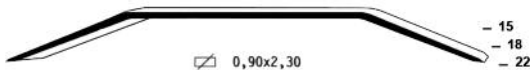

B (A - 35 - JK 560)

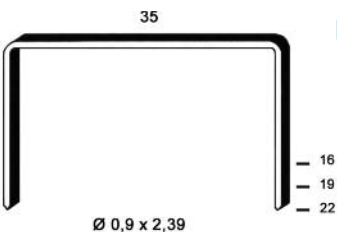

CODE	DESCRIPTION				SEITE
6B-161	B-16 Kupfer	10 000	720 000	936	6
6B-191	B-19 Kupfer	10 000	600 000	720	6
6B-221	B-22 Kupfer	7 500	450 000	585	7

BC (T 25 - MT 25 - Ro 88 - Mek 88 - Rap 36 - Ro MS20 - SAM 643 P7 - Maestri 88 - 7)

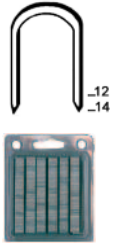

CODE	DESCRIPTION				SEITE
201412	BC 14-12	1 000	200 000	30	5
201414	BC 14-14	1 000	200 000	32	5

CODE	DESCRIPTION			SEITE
201412BL	BC 14-12 Blister 960	20	3	5
201414BL	BC 14-14 Blister 960	20	3	5

BM (SW 9040)

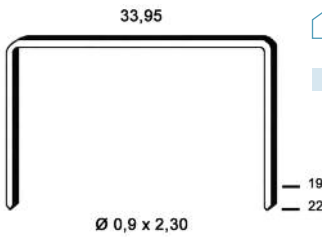

CODE	DESCRIPTION			SEITE
6BM191	BM-19 Kupfer	20 000	24	
6BM221	BM-22 Kupfer	15 000	20	

SCHIEFERHAKEN



CODE	DESCRIPTION			SEITE
HOOK0802	Schieferhaken 2,7 x 80 rostfrei 17%	750	1	14
HOOK0902	Schieferhaken 2,7 x 90 rostfrei 17%	750	1	14
HOOK1002	Schieferhaken 2,7 x 100 rostfrei 17%	750	1	14
HOOK1102	Schieferhaken 2,7 x 110 rostfrei 17%	750	1	14
HOOK1202	Schieferhaken 2,7 x 120 rostfrei 17%	750	1	14
HOOK0804B	Schieferhaken 2,7 x 80 rostfrei 18/10 schwarz	750	1	14
HOOK0904B	Schieferhaken 2,7 x 90 rostfrei 18/10 schwarz	750	1	14
HOOK1004B	Schieferhaken 2,7 x 100 rostfrei 18/10 schwarz	750	1	14
HOOK1104B	Schieferhaken 2,7 x 110 rostfrei 18/10 schwarz	750	1	14
HOOK1204B	Schieferhaken 2,7 x 120 rostfrei 18/10 schwarz	750	1	14

D (95 - SB 5019 - 50 - 2745/3405 - PW - 5 - Rapid 50)

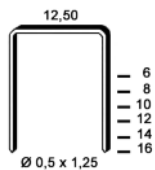

CODE	DESCRIPTION				SEITE
6D-061	D-06 verzinkt	5 000	180 000	22	
6D-081	D-08 verzinkt	5 000	140 000	20	
6D-101	D-10 verzinkt	5 000	120 000	17	
6D-121	D-12 verzinkt	5 000	110 000	20	
6D-141	D-14 verzinkt	5 000	90 000	18	
6D-161	D-16 verzinkt	5 000	45 000	10	

E (KL 6000 - 90 - 18 - 3004 - 2750 - 3423 - L/N4450 - JK 781)

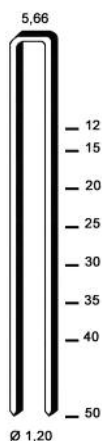

CODE	DESCRIPTION				SEITE
6E-121	E-12 verzinkt geharzt	12 000	60 000	14	10
6E-151	E-15 verzinkt geharzt	5 000	50 000	14	10
6E-201	E-20 verzinkt geharzt	5 000	50 000	18	10
6E-251	E-25 verzinkt geharzt	5 000	40 000	18	10
6E-301	E-30 verzinkt geharzt	5 000	40 000	20	10
6E-351	E-35 verzinkt geharzt	5 000	20 000	12	10
6E-401	E-40 verzinkt geharzt	5 000	20 000	14	10
6E-501	E-50 verzinkt geharzt	2 000	20 000	15	
6E-159	E-15 rostfrei	8 000	40 000	10	10
6E-209	E-20 rostfrei	8 000	40 000	14	10
6E-259	E-25 rostfrei	4 000	40 000	17	10
6E-309	E-30 rostfrei	4 000	40 000	20	10
6E-409	E-40 rostfrei	4 000	20 000	14	10
6E-152	E-15 D-Spitze verzinkt	8 000	40 000	11	10

EM (KL 5000 - 3755)

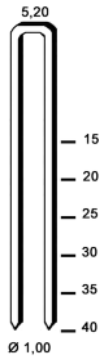

CODE	DESCRIPTION				SEITE
6EM151	EM-15 verzinkt geharzt	7 500	75 000	17	10
6EM201	EM-20 verzinkt geharzt	5 000	50 000	14	10
6EM251	EM-25 verzinkt geharzt	6 000	60 000	21	10
6EM301	EM-30 verzinkt geharzt	6 000	60 000	25	10
6EM351	EM-35 verzinkt geharzt	5 000	50 000	24	10
6EM401	EM-40 verzinkt geharzt	5 000	40 000	22	10

ES (Nov.J145 - Esco 606)

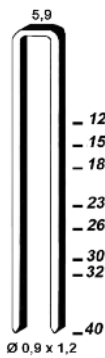

CODE	DESCRIPTION				SEITE
6ES121	ES-12 verzinkt	8 000	80 000	14	10
6ES151	ES-15 verzinkt	6 000	60 000	13	10/14
6ES181	ES-18 verzinkt	6 000	60 000	16	10/14
6ES231	ES-23 verzinkt	4 000	40 000	13	10/14
6ES261	ES-26 verzinkt	4 000	40 000	15	10/14
6ES301	ES-30 verzinkt	4 000	40 000	16	10/14
6ES321	ES-32 verzinkt	2 000	20 000	9	10/14
6ES401	ES-40 verzinkt	2 000	20 000	11	10
6ES269	ES-26 rostfrei	4 000	40 000	15	10/14

FB (STCR 5019 - JK 69)

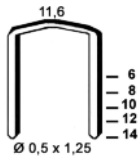

CODE	DESCRIPTION				SEITE
6FB061	FB-06 verzinkt	5 000	100 000	12	5
6FB081	FB-08 verzinkt	5 000	100 000	13	5
6FB101	FB-10 verzinkt	5 000	100 000	16	5
6FB121	FB-12 verzinkt	4 000	40 000	7	5
6FB141	FB-14 verzinkt	4 000	40 000	7	5

G (W 18 - M - G 4450 - JK 782 - 44)

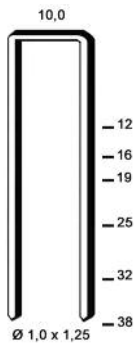

CODE	DESCRIPTION				SEITE
6G-121	G-12 verzinkt	7 800	78 000	17	
6G-161	G-16 verzinkt	5 200	52 000	18	
6G-191	G-19 verzinkt	5 200	52 000	21	
6G-251	G-25 verzinkt	2 600	26 000	14	
6G-321	G-32 verzinkt	2 600	26 000	18	
6G-381	G-38 verzinkt	2 600	26 000	20	

GB (KL 500 - 3424 - 3413 - 3761)

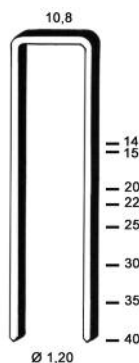

CODE	DESCRIPTION				SEITE
6GB151	GB-15 verzinkt geharzt	5 000	50 000	17	10
6GB201	GB-20 verzinkt geharzt	4 800	48 000	20	10
6GB221	GB-22 verzinkt geharzt	2 400	24 000	13	10
6GB251	GB-25 verzinkt geharzt	2 400	24 000	12	10
6GB301	GB-30 verzinkt geharzt	2 400	24 000	14	10
6GB351	GB-35 verzinkt geharzt	2 400	24 000	16	10
6GB401	GB-40 verzinkt geharzt	2 400	24 000	19	10
6GB148	GB-14 Spreizklammer rostfrei	4 800	48 000	16	10
6GB228	GB-22 Spreizklammer rostfrei	2 400	24 000	13	10
6GB359	GB-35 rostfrei	2 400	24 000	18	10
6GB409	GB-40 rostfrei	2 400	24 000	18	10

GX (1310 - GS 16)

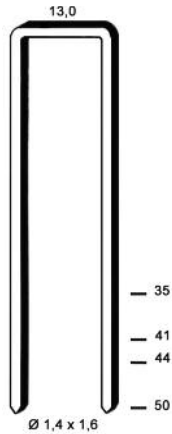

CODE	DESCRIPTION			SEITE
6GX351	GX-35 verzinkt	10 000	12	
6GX411	GX-41 verzinkt	9 800	14	
6GX441	GX-44 verzinkt	8 400	13	
6GX501	GX-50 verzinkt	7 000	11	

H (JK 664 - 92 - 192 - SL 5035 - I 870)

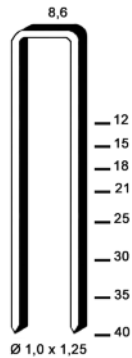

CODE	DESCRIPTION				SEITE
6H-121	H-12 verzinkt	7 500	75 000	20	9
6H-151	H-15 verzinkt	5 000	50 000	16	9
6H-181	H-18 verzinkt	5 000	50 000	19	9
6H-211	H-21 verzinkt	2 500	25 000	11	9
6H-251	H-25 verzinkt	2 500	25 000	13	9
6H-301	H-30 verzinkt	2 500	25 000	15	
6H-351	H-35 verzinkt	2 500	25 000	17	
6H-401	H-40 verzinkt	2 500	25 000	19	
6H-151D	H-15 Spreizklammer	5 000	100 000	32	9
6H-251D	H-25 Spreizklammer	2 500	50 000	26	9

HB (98 - 33 - JK 689)

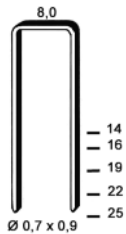

CODE	DESCRIPTION				SEITE
6HB141	HB-14 verzinkt	1 400	56 000	9	
6HB161	HB-16 verzinkt	1 400	56 000	10	
6HB191	HB-19 verzinkt	1 400	56 000	11	
6HB221	HB-22 verzinkt	1 400	56 000	13	
6HB251	HB-25 verzinkt	5 000	80 000	21	

HR18

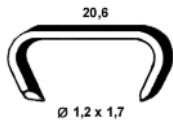

CODE	DESCRIPTION				SEITE
61HR181	HR18 verzinkt	2 500	50 000	50	4

JK590

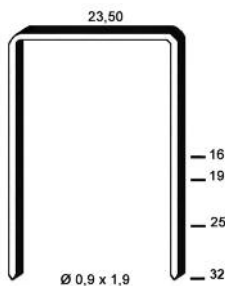

CODE	DESCRIPTION			SEITE
400516	JK590-16 Kupfer	10 000	7	
400517	JK590-19 Kupfer	10 000	8	7
400519	JK590-25 Kupfer	10 000	10	7
400521	JK590-32 Kupfer	10 000	12	7

K (97 - SX 5035)

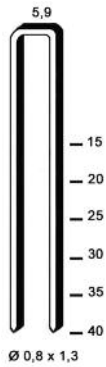

CODE	DESCRIPTION				SEITE
6K-151	K-15 verzinkt	8 000	40 000	11	
6K-201	K-20 verzinkt	8 000	40 000	14	
6K-251	K-25 verzinkt	4 000	40 000	17	
6K-301	K-30 verzinkt	4 000	40 000	20	
6K-351	K-35 verzinkt	4 000	40 000	24	
6K-401	K-40 verzinkt	4 000	40 000	26	

L (KG 7000 - 100 - 14 - 155 - S5 - 5008 - S106 - N - G 5562 - Rino 90)

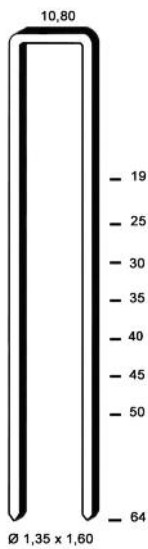

CODE	DESCRIPTION				SEITE
6L-191	L-19 verzinkt geharzt	26 000	1 456 000	1 238	
6L-251	L-25 verzinkt geharzt	19 100	1 069 600	930	11
6L-301	L-30 verzinkt geharzt	15 600	873 600	839	11
6L-351	L-35 verzinkt geharzt	13 900	778 400	856	11/12
6L-401	L-40 verzinkt geharzt	12 100	677 600	881	11/12
6L-451	L-45 verzinkt geharzt	10 400	582 400	833	11/12
6L-501	L-50 verzinkt geharzt	10 400	582 400	815	11/12
6L-641	L-64 verzinkt geharzt	6 900	386 400	734	12
6L-302	L-30 Spreizklammer	20 000	1 120 000	1 075	11
6L-452	L-45 Spreizklammer	14 000	784 000	1 121	11/12
6L-502	L-50 Spreizklammer	10 400	582 400	920	11/12

MV (MG 318 - 23)

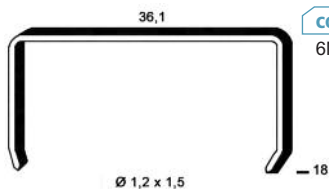

CODE	DESCRIPTION				SEITE
6MV181	MV-18	5 000	600 000	540	

O (JK 690 - 93 - 97 - 34 - 2747 - N 590 - Ro 4 - Rap 137 - Rino 93)

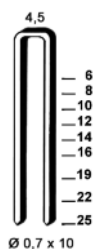

CODE	DESCRIPTION				SEITE
6O-061	O-06 verzinkt	15 000	300 000	21	
6O-081	O-08 verzinkt	10 000	200 000	18	
6O-101	O-10 verzinkt	10 000	200 000	20	9
6O-121	O-12 verzinkt	10 000	200 000	26	9
6O-141	O-14 verzinkt	5 000	100 000	14	9
6O-161	O-16 verzinkt	5 000	100 000	16	9
6O-191	O-19 verzinkt	5 000	100 000	19	9
6O-221	O-22 verzinkt	5 000	100 000	22	9
6O-251	O-25 verzinkt	5 000	100 000	24	9
6O-101D	O-10 Spreizklammer	10 000	200 000	20	9

P (SP 5019 - W 50 - J 5 - JK 682)

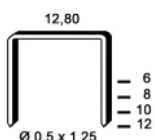

CODE	DESCRIPTION				SEITE
6P-061	P-06 verzinkt	10 000	100 000	12	
6P-081	P-08 verzinkt	10 000	100 000	15	
6P-101	P-10 verzinkt	8 000	80 000	13	
6P-121	P-12 verzinkt	6 000	60 000	11	

PB (Rapid 73 - Novus D-53 F - JK 34)

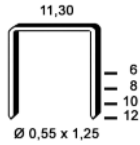

CODE	DESCRIPTION				SEITE
6PB061	PB-06 verzinkt	5 000	120 000	13	4
6PB081	PB-08 verzinkt	3 600	129 600	16	4
6PB101	PB-10 verzinkt	2 900	34 800	5	4
6PB121	PB-12 verzinkt	2 100	25 200	4	4

PF (Rap.11 - 34 - 132 - 1100 - Régur 11 - 4 - T50 - JK 671)

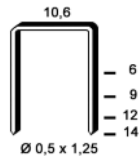

CODE	DESCRIPTION				SEITE
6PF061	PF-06 verzinkt	5 000	100 000	11	4/5
6PF091	PF-09 verzinkt	5 000	100 000	15	4/5
6PF121	PF-12 verzinkt	4 000	80 000	15	4
6PF141	PF-14 verzinkt	3 000	60 000	11	4



CODE	DESCRIPTION			SEITE
6PF061BL	PF-06 verzinkt blister 1440	20	3	4/5
6PF091BL	PF-09 verzinkt Blister 1440	20	4	4/5
6PF121BL	PF-12 verzinkt Blister 1440	20	5	4
6PF141BL	PF-14 verzinkt Blister 1440	20	5	4

PM (SB 3020 - 72 - B - 3 - Swing 90 - 101 - 108 - 181 - 2)

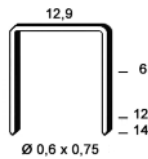

CODE	DESCRIPTION				SEITE
6PM061	PM-06 verzinkt	20 000	320 000	26	
6PM121	PM-12 verzinkt	10 000	160 000	19	
6PM141	PM-14 verzinkt	10 000	160 000	19	

Q (HD 7900 - SD 9100 - 170 - 180 - 15 - Q 6774 - M3)

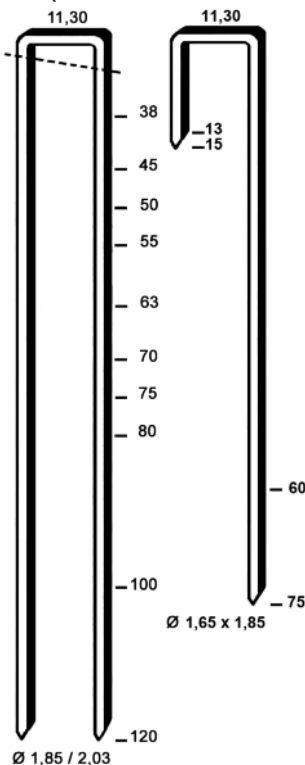

CODE	DESCRIPTION				SEITE
6Q-381	Q-38 verzinkt geharzt	8 800	492 800	789	12
6Q-451	Q-45 verzinkt geharzt	7 500	420 000	840	12
6Q-501	Q-50 verzinkt geharzt	7 500	420 000	924	12
6Q-551	Q-55 verzinkt geharzt	6 300	352 800	847	12
6Q-631	Q-63 verzinkt geharzt	5 000	350 000	980	12
6Q-701	Q-70 verzinkt geharzt	5 000	350 000	1 050	
6Q-751	Q-75 verzinkt geharzt	5 000	350 000	1 225	
20Q-6013	Q-60/13 verzinkt geharzt	6 000	540 000	918	12
20Q-7515	Q-75/15 verzinkt geharzt	5 000	450 000	1 013	
20Q-9175	Q-75/15 Ø 2,0 verzinkt geharzt	4 200	378 000	869	
6Q-459	Q-45 rostfrei	7 500	420 000	840	12
6Q-509	Q-50 rostfrei	7 500	420 000	924	12
6Q-639	Q-63 rostfrei	5 000	280 000	784	12
6Q-801	Ø 2 - Q-80 verzinkt geharzt	5 000	220 000	904	
6Q-1001	Ø 2 - Q-100 verzinkt geharzt	3 680	176 640	922	
6Q-1201	Ø 2 - Q-120 verzinkt geharzt	3 200	153 600	960	

R (JK 561 - 32)

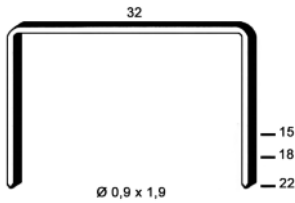

CODE	DESCRIPTION				SEITE
6R-151	R-15 Kupfer	20 000	1 000 000	740	6/7
6R-181	R-18 Kupfer	20 000	900 000	747	6/7
6R-221	R-22 Kupfer	20 000	720 000	677	7

R555 (JK 555)



CODE	DESCRIPTION				SEITE
R555-15	R555-15 Kupfer	24 000	1 152 000	933	6
R555-18	R555-18 Kupfer	24 000	1 152 000	979	6

S (16 NC - S 4)

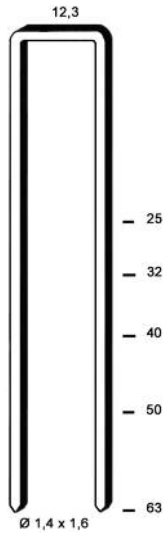

CODE	DESCRIPTION				SEITE
6S-251	S-25 verzinkt	20 000	1 300 000	1 170	11
6S-321	S-32 verzinkt	20 000	1 300 000	1 430	11
6S-401	S-40 verzinkt	10 000	900 000	1 260	11
6S-501	S-50 verzinkt	10 000	780 000	1 248	11
6S-631	S-63 verzinkt	10 000	600 000	1 440	11
6S-251D	S-25 Spreizklammer verzinkt	20 000	600 000	540	11

SP (SP 1906 - P3 - JK 16)



CODE	DESCRIPTION				SEITE
6SP061	SP-06 verzinkt	5 000	500 000	15	

TB (KL 4000)

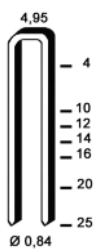

CODE	DESCRIPTION				SEITE
6TB101	TB-10 verzinkt	20 000	200 000	20	
6TB121	TB-12 verzinkt	10 000	200 000	24	
6TB141	TB-14 verzinkt	10 000	160 000	21	
6TB161	TB-16 verzinkt	10 000	160 000	24	
6TB201	TB-20 verzinkt	10 000	100 000	19	
6TB251	TB-25 verzinkt	10 000	100 000	29	
6TB049	TB-04 rostfrei	10 000	200 000	12	

TK (SJK - SJ 3020 - S1)

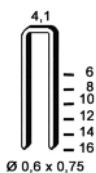

CODE	DESCRIPTION				SEITE
6TK061	TK-06 stanox	14 000	560 000	28	
6TK081	TK-08 stanox	20 000	360 000	22	
6TK101	TK-10 stanox	20 000	320 000	26	
6TK121	TK-12 stanox	20 000	240 000	22	
6TK141	TK-14 stanox	10 000	240 000	24	
6TK161	TK-16 stanox	10 000	180 000	20	

U (74 - 40 - N 3)

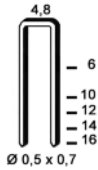

CODE	DESCRIPTION				SEITE
6U-061	U-06 verzinkt	20 000	320 000	16	
6U-101	U-10 verzinkt	23 000	184 000	13	
6U-121	U-12 verzinkt	18 000	180 000	13	
6U-141	U-14 verzinkt	14 000	210 000	27	
6U-161	U-16 verzinkt	14 000	210 000	21	

V (KL 7100 - 7 - 71 - 3G - 30 - L3G - C - G3 - Rino 7 - JK 670)

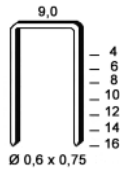

CODE	DESCRIPTION				SEITE
6V-041	V-04 verzinkt	20 000	300 000	12	8
6V-061	V-06 verzinkt	10 000	360 000	18	8/9
6V-081	V-08 verzinkt	10 000	300 000	21	8/9
6V-101	V-10 verzinkt	10 000	240 000	19	8/9
6V-121	V-12 verzinkt	10 000	240 000	24	8/9
6V-141	V-14 verzinkt	10 000	240 000	26	8/9
6V-161	V-16 verzinkt	5 000	180 000	20	8/9
6V-121D	V-12 Spreizklammer	10 000	150 000	17	8/9
6V-141D	V-14 Spreizklammer	7 500	112 500	14	8/9
6V-069	V-06 rostfrei	15 000	225 000	11	8/9
6V-109	V-10 rostfrei	10 000	150 000	12	8/9
6V-149	V-14 rostfrei	7 500	112 500	12	8/9

VF (KL 1400)

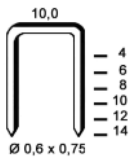

CODE	DESCRIPTION				SEITE
6VF041	VF-04 verzinkt	20 000	480 000	24	9
6VF061	VF-06 verzinkt	10 000	360 000	22	9
6VF081	VF-08 verzinkt	10 000	240 000	17	9
6VF101	VF-10 verzinkt	10 000	240 000	22	9
6VF121	VF-12 verzinkt	10 000	240 000	24	9
6VF141	VF-14 verzinkt	10 000	180 000	20	9

VS (26 - 66 - JK 1)

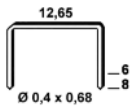

CODE	DESCRIPTION				SEITE
6VS061	VS-06	5 000	100 000	5	4
6VS081	VS-08	3 800	76 000	3	
1003932	VS-06 ondulées	5 000	500 000	20	4

CODE	DESCRIPTION			SEITE
6VS061BL	VS-06 verzinkt Blister 2860	20	3	4

VX (Rapid 36 - 53 - 253 - JT 21 - T 27)

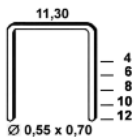

CODE	DESCRIPTION				SEITE
6VX041	VX-04 verzinkt	10 000	500 000	20	4
6VX061	VX-06 verzinkt	6 000	300 000	21	4
6VX081	VX-08 verzinkt	5 000	250 000	23	4
6VX101	VX-10 verzinkt	4 000	200 000	14	4
6VX121	VX-12 verzinkt	3 000	150 000	12	

CODE	DESCRIPTION			SEITE
6VX041BL	VX-04 verzinkt Blister 2000	20	2	4
6VX061BL	VX-06 verzinkt Blister 1000	20	1	4
6VX081BL	VX-08 verzinkt Blister 1000	20	2	4

VZ (37 - Rap.19 - 135 - Roc.14)

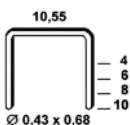

CODE	DESCRIPTION				SEITE
6VZ041	VZ-04 verzinkt	8 400	336 000	13	5
6VZ061	VZ-06 verzinkt	6 700	268 000	13	5
6VZ081	VZ-08 verzinkt	5 000	200 000	12	5
6VZ101	VZ-10 verzinkt	3 300	165 000	12	5

CODE	DESCRIPTION			SEITE
6VZ061BL	VZ-06 verzinkt Blister 2800	20	3	5

WC (16 WC - 140 - S 2)

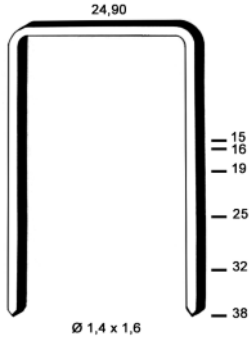

CODE	DESCRIPTION				SEITE
6WC161	WC-16 verzinkt	11 900	999 600	840	13
6WC191	WC-19 verzinkt	10 500	882 000	794	13
6WC251	WC-25 verzinkt	7 700	646 800	712	13
6WC321	WC-32 verzinkt	6 300	529 200	582	13
6WC381	WC-38 verzinkt	4 900	441 600	659	13
6WC151D	WC-15 verzinkt Spreizklammer	12 600	882 000	741	13
6WC158D	WC-15 Aluminium Spreizklammer	10 000	700 000	196	13

WD (BK 2500 - 3764)

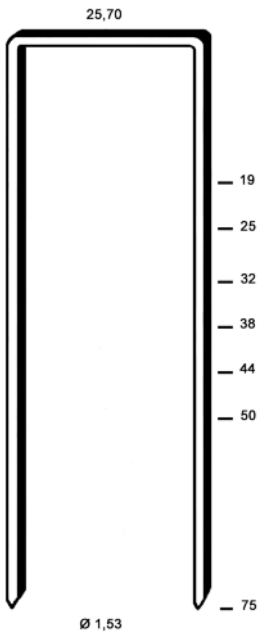

CODE	DESCRIPTION				SEITE
6WD191	WD-19 verzinkt geharzt	8 000	672 000	638	
6WD251	WD-25 verzinkt geharzt	6 400	537 600	640	
6WD321	WD-32 verzinkt geharzt	5 400	453 600	621	
6WD381	WD-38 verzinkt geharzt	4 000	336 000	504	
6WD441	WD-44 verzinkt geharzt	5 200	436 800	778	
6WD501	WD-50 verzinkt geharzt	3 200	268 800	538	
6WD751	WD-75 verzinkt geharzt	2 800	235 200	565	

WN 25 (CF - W - 110 - 3445 - 3446)

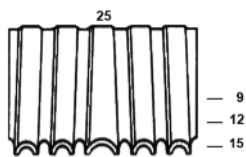

CODE	DESCRIPTION				SEITE
6WN091	WN25-09	16 000	960 000	893	13
6WN121	WN25-12	14 000	840 000	1 100	13
6WN151	WN25-15	12 000	720 000	1 080	13

WN 35 (3447)

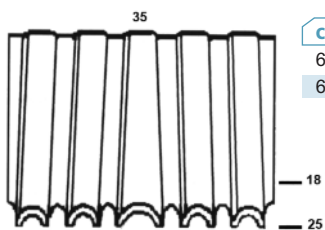

CODE	DESCRIPTION				SEITE
6WN181	WN35-18	6 300	378 000	1 021	
6WN251	WN35-25	5 000	200 000	760	

WP (BS 29000)

27,00

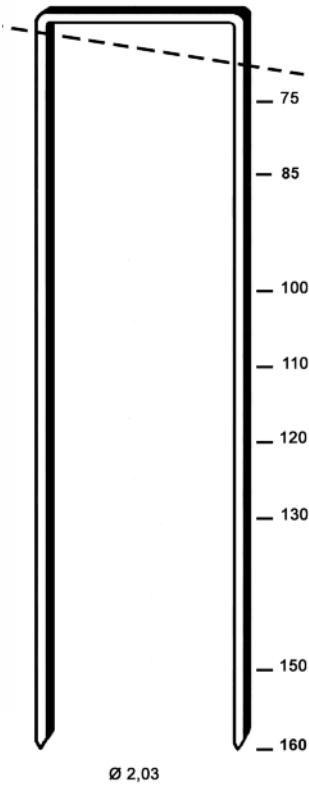

CODE	DESCRIPTION				SEITE
6WP1001	WP-100 verzinkt geharzt	1 700	102 000	561	12
6WP1201	WP-120 verzinkt geharzt	1 100	66 000	426	12
6WP1501	WP-150 verzinkt geharzt	1 100	66 000	528	12
6WP1601	WP-160 verzinkt geharzt	1 100	66 000	563	12
6WP759	WP-75 rostfrei	2 200	132 000	568	12
6WP859	WP-85 rostfrei	1 700	81 600	359	12
6WP1009	WP-100 rostfrei	1 700	102 000	561	12
6WP1109	WP-110 rostfrei	1 100	66 000	396	12
6WP1209	WP-120 rostfrei	1 100	66 000	426	12
6WP1309	WP-130 rostfrei	1 100	66 000	429	12
6WP1509	WP-150 rostfrei	1 100	66 000	528	12
6WP1609	WP-160 rostfrei	1 100	66 000	563	12

WS (17 - P - W 5562 - JK 784)

26,50

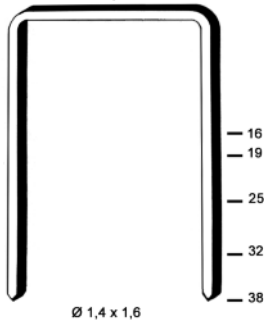

CODE	DESCRIPTION				SEITE
6WS161	WS-16 verzinkt	12 300	861 000	689	13
6WS191	WS-19 verzinkt	10 800	756 000	680	13
6WS251	WS-25 verzinkt	7 900	553 000	608	13
6WS321	WS-32 verzinkt	6 500	455 000	592	13
6WS381	WS-38 verzinkt	5 000	350 000	560	13

Z (KG 700 - 76 - 3431 - 3418 - 3432 - 3425)

11,10

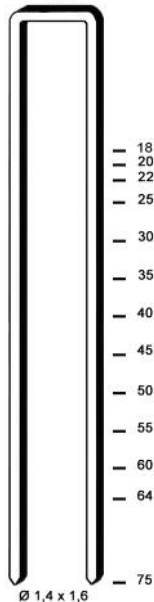

CODE	DESCRIPTION				SEITE
6Z-201	Z-20 verzinkt geharzt	18 800	902 400	596	
6Z-251	Z-25 verzinkt geharzt	15 000	945 000	766	11
6Z-301	Z-30 verzinkt geharzt	15 000	765 000	727	11
6Z-351	Z-35 verzinkt geharzt	10 000	630 000	687	11/12
6Z-401	Z-40 verzinkt geharzt	10 000	570 000	701	11/12
6Z-451	Z-45 verzinkt geharzt	10 000	560 000	773	11/12
6Z-501	Z-50 verzinkt geharzt	10 000	560 000	851	11/12
6Z-551	Z-55 verzinkt geharzt	5 000	315 000	555	12
6Z-601	Z-60 verzinkt geharzt	5 000	315 000	586	12
6Z-641	Z-64 verzinkt geharzt	5 000	315 000	643	12
6Z-751	Z-75 verzinkt geharzt	5 000	220 000	526	
6Z-181D	Z-18 verzinkt geharzt Spreizklammer	23 800	1 713 600	1 114	
6Z-221D	Z-22 verzinkt geharzt Spreizklammer	16 800	806 400	589	
6Z-251D	Z-25 verzinkt geharzt Spreizklammer	15 800	758 400	607	11
6Z-351D	Z-35 verzinkt geharzt Spreizklammer	12 700	609 600	701	11/12
6Z-409	Z-40 rostfrei	11 100	777 000	933	11/12
6Z-509	Z-50 rostfrei	9 500	532 000	830	11/12



NAGELTECHNIK



Druckluftnagler

26

Druckluftnägel

32

PN-C2

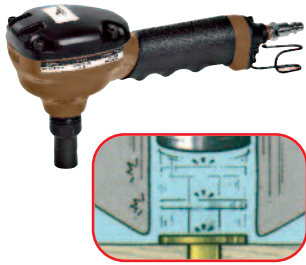

CODE	R	€/1
12PNC2W Lieferung mit 3 Aufsätzen	B	320,00

NASE	Ø MAX KOPF	Ø DRAHT	LÄNGE DER NÄGEL
breit	15,2 mm	4,9 - 7,5 mm	100 - 180 mm
magnetisch	8,7 mm	2,9 - 4,1 mm	50 - 90 mm
finish	4,9 mm	2,0 - 3,3 mm	32 - 64 mm

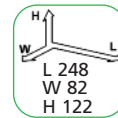

PN-C2-U



CODE	R	€/1
12PNC2CR	B	320,00

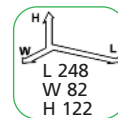

AL-35 P1



CODE	DIM.	R	€/1
12B2335	15 - 35 mm	B	370,00

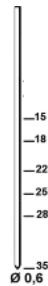

TYPE	SEITE
AL	36

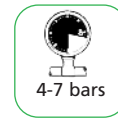
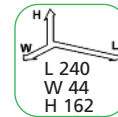

J-35 P1



CODE	DIM.	R	€/1
12B1835	10 - 35 mm	B	160,00

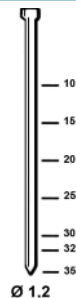

TYPE	SEITE
J	38

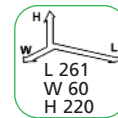

J-55 P1



CODE	DIM.	R	€/1
12B1855	15 - 50 mm	B	220,00

TYPE	SEITE
GA	37
J	38

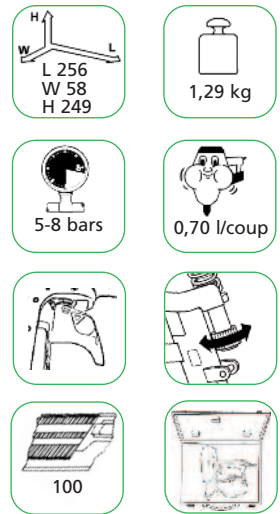

N-64 P1



CODE	DIM.	R	€/1
12B1664	20 - 64 mm	B	410,00

TYPE	SEITE
N	39

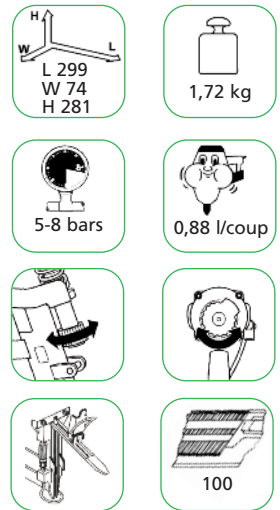

T 64 P1



CODE	DIM.	R	€/1
12T2264	25 - 64 mm	B	620,00

TYPE	SEITE
T	40

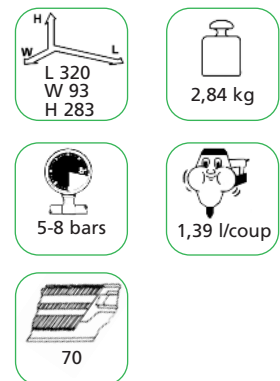

DA-64 P1



CODE	DIM.	R	€/1
12A3464	25 - 64 mm	B	470,00

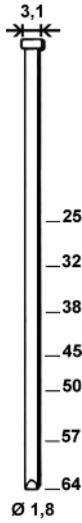

TYPE	SEITE
DA	37

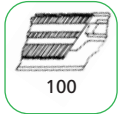
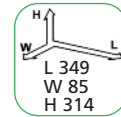

BR-64 P1



CODE	DIM.	R	€/1
12A2564	32 - 64 mm Ø 1,8	B	470,00



TYPE	SEITE
BR-18	37

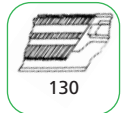
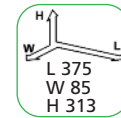

AP 50 Alu



CODE	DIM.	R	€/1
10AP50	22 - 50 mm	B	980,00

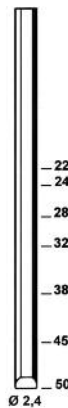

TYPE	SEITE
SD	40

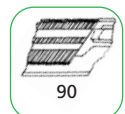
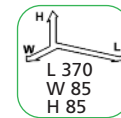

SKN 30 E



CODE	DIM.	R	€/1
13ME30	15 - 30 mm	B	310,00

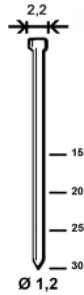

TYPE	SEITE
J	38

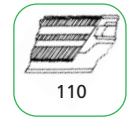
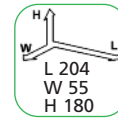

C 31/45 P1



CODE	DIM.	R	€/1
12C3145	19 - 45 mm	B	720,00

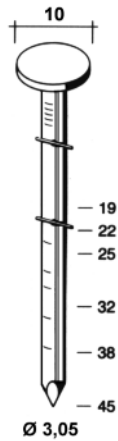

TYPE	SEITE
ROOFING	42

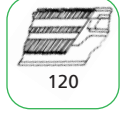
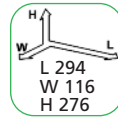

C 21/50 P1



CODE	DIM.	R	€/1
12C2150	32 - 50 mm	B	580,00

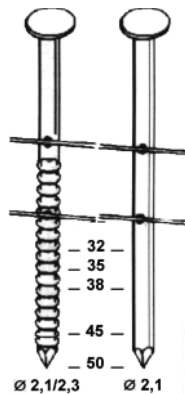

TYPE	SEITE
COILS 21	42

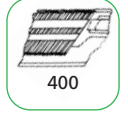
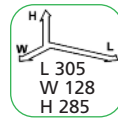

C 28/70 P1



CODE	DIM.	R	€/l
12C2965	35 - 70 mm	B	620,00
	Ø 2,3 - 2,5 - 2,8		

TYPE	SEITE
COILS SHEET	41
COILS 23-25-28	43
SCRAIL	48

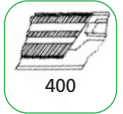
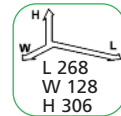
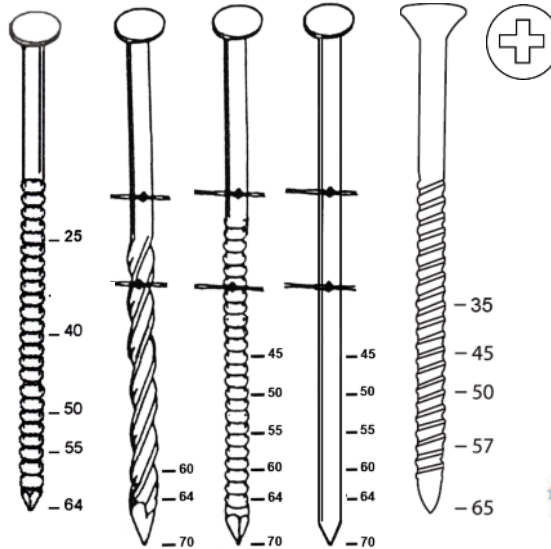

C 38/90 P1



CODE	DIM.	R	€/l
12C3890	45 - 90 mm	B	730,00
	Ø 2,3 - 2,5 - 2,8 - 3,1		

TYPE	SEITE
COILS SHEET	41
COILS 23-25-28-31	43
SCRAIL	48

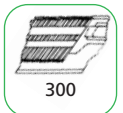
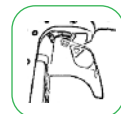
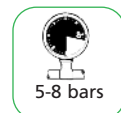
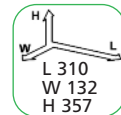
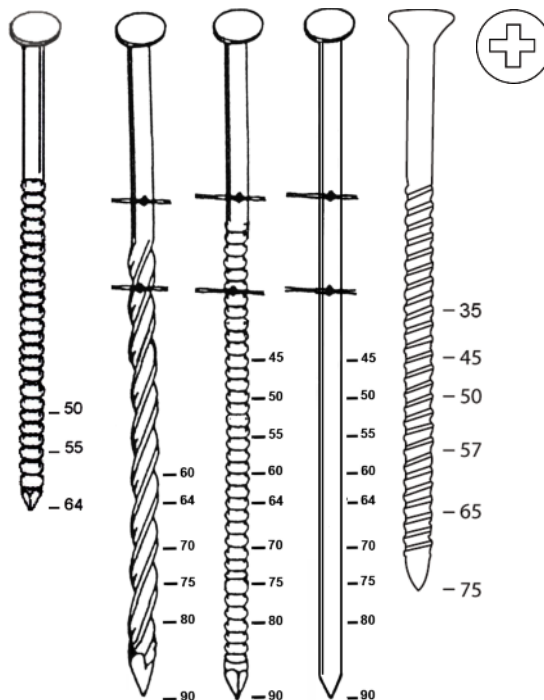

C 23/55 P1



CODE	DIM.	R	€/l
12C2357	32 - 55 mm	B	610,00

TYPE	SEITE
BO	42

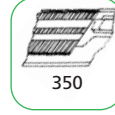
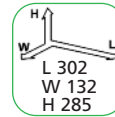

C 29/70 P1



CODE	DIM.	R	€/l
12C2970	45 - 70 mm Ø 2,3 - 2,5 - 2,8	B	680,00

TYPE	SEITE
COILS 23-25-28	43

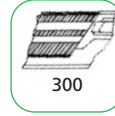
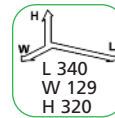

C 33/80 P1



CODE	DIM.	R	€/l
12C3383	45 - 80 mm Ø 2,3 - 2,5 - 2,8 - 3,1	B	690,00

TYPE	SEITE
COILS 23-25-28-31	43

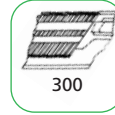
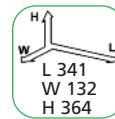

C 38/100 EPAL



CODE	DIM.	R	€/l
------	------	---	-----

12C38100

55 - 100 mm B
Ø 2,3 - 2,5 - 2,8 - 3,1 - 3,4

870,00

TYPE	SEITE
COILS 23-25-28-31-34	43

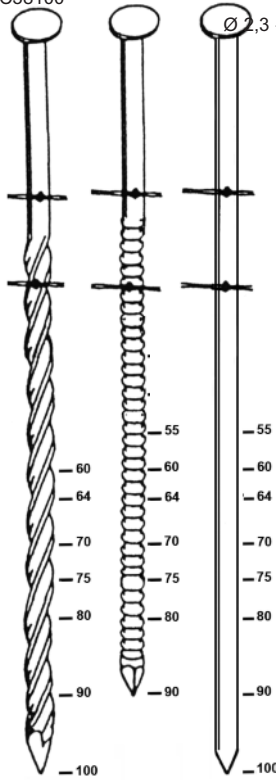
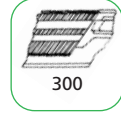
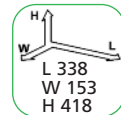

C 38/130 P1



CODE	DIM.	R	€/l
------	------	---	-----

12C38130

80 - 130 mm B
Ø 3,1 - 3,4 - 3,8

1 330,00

TYPE	SEITE
COILS 31-34-38	43

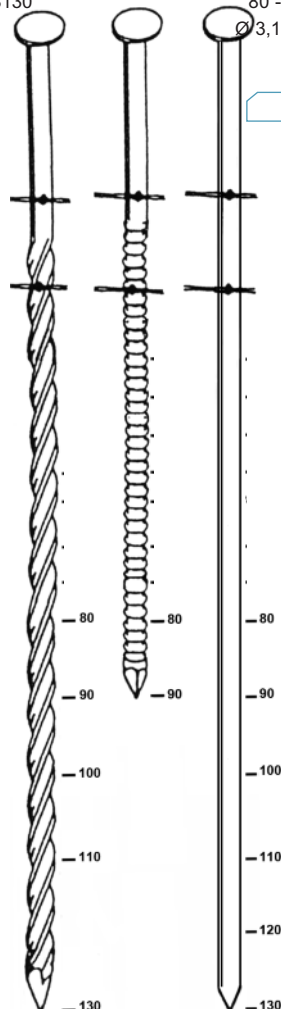
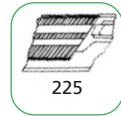
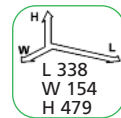

F 38/100 P1



CODE	DIM.	R	€/1
------	------	---	-----

12A22100 50 - 100 mm B 700,00
Ø 2,9 à 3,8

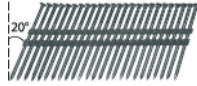

TYPE	SEITE
20°	44

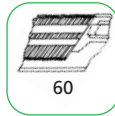
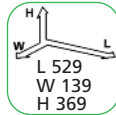

F 42/130 P1

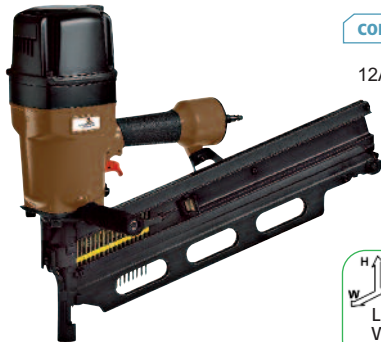

CODE	DIM.	R	€/1
------	------	---	-----

12A22130 90 - 130 mm B 1 240,00
Ø 3,4 à 4,2

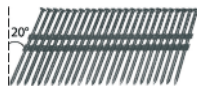

TYPE	SEITE
20°	44

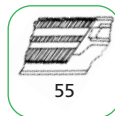
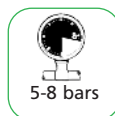
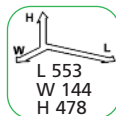

F 50/160 P1

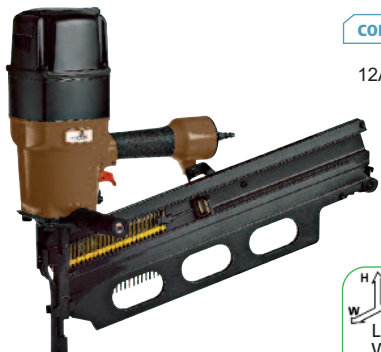

CODE	DIM.	R	€/1
------	------	---	-----

12A22160 100 - 160 mm B 1 370,00
Ø 3,8 à 4,6

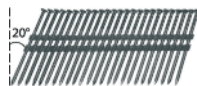

TYPE	SEITE
20°	44

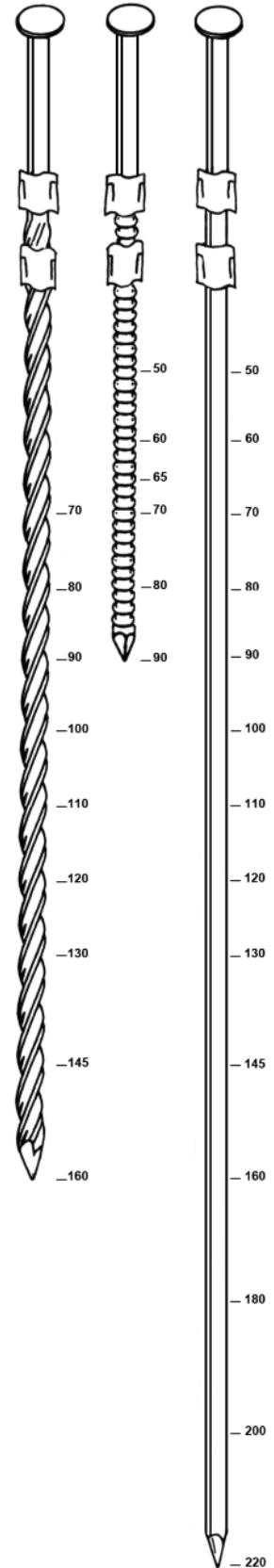
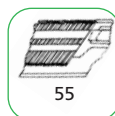
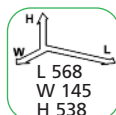

NAGELTECHNIK Druckluftnagler für papiergebundene Nägel

D 90 P1



CODE	DIM.	R	€/l
------	------	---	-----

12N90PA 50 - 90 mm B 620,00
Ø 2,8 - 3,1

TYPE	SEITE
------	-------

34° 46

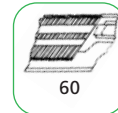
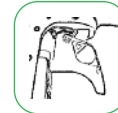
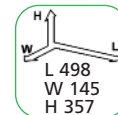
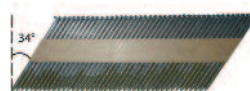
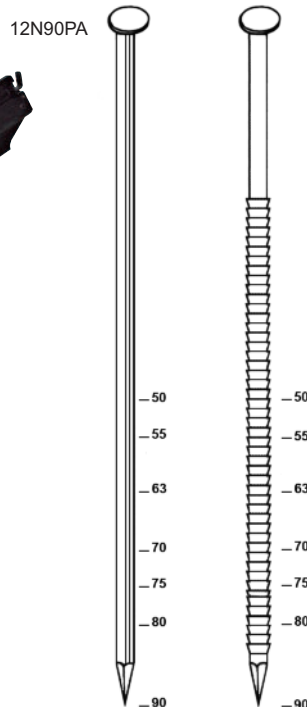

NAGELTECHNIK Ankernagler

F 40/60 P1



CODE	DIM.	R	€/l
------	------	---	-----

12A2260M 40 - 60 mm B 600,00
Ø 4,0

TYPE	SEITE
------	-------

ANCRAGE 25° 48

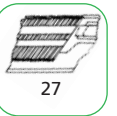
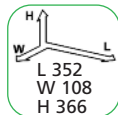
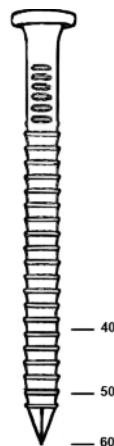

C 41/65 P1



CODE	DIM.	R	€/l
------	------	---	-----

12C3365M 40 - 60 mm B 810,00
Ø 4,1

TYPE	SEITE
------	-------

MAX 41 48

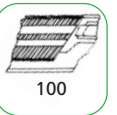
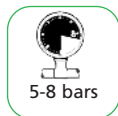
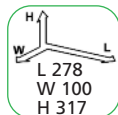

D 90 G1



CODE	DIM.	R	€/1
12A3490N	50 - 90 mm Ø 2,8 - 3,1	B	640,00

TYPE	SEITE
34° + gaz GAZ0010	47

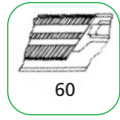
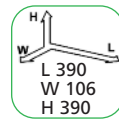

F 40/65 G1

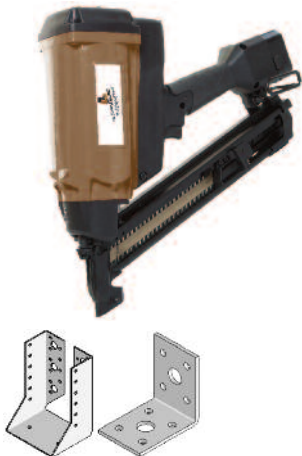

CODE	DIM.	R	€/1
12A3465MG	35 - 60 mm Ø 4,0	B	890,00

TYPE	SEITE
ANKER NAGEL 34° + gaz GAZ0010	48

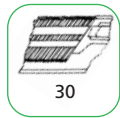
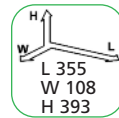

ACCESSOIRES F 40-65 G1

CODE	DESCRIPTION	R	€/1
12BAT6V	Batterie 6 V - 1,65 Ah NiMH	B	55,00
12KITCHA	Kit chargeur / adaptateur	B	26,00

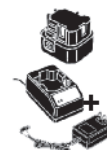

GAZ

CODE	DESCRIPTION	R	€/1
GAZ0010	Gaz bois Trak-It W3 (IM 350)	B	15,00
GAZ0020	Gaz jaune (30 ml)	B	16,00



SERIE AL (SN 06 - mini 0,6 - S 062 - MP 6 - 6 - JS - JF)

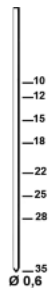

CODE	DESCRIPTION				SEITE
6AL101	Finettes AL-10 stanox	20 000	480 000	14	
6AL121	Finettes AL-12 stanox	20 000	480 000	14	
6AL151	Finettes AL-15 stanox	20 000	480 000	19	26
6AL181	Finettes AL-18 stanox	20 000	480 000	24	26
6AL221	Finettes AL-22 stanox	20 000	320 000	16	26
6AL251	Finettes AL-25 stanox	20 000	320 000	22	26
6AL281	Finettes AL-28 stanox	20 000	240 000	19	26
6AL351	Finettes AL-35 stanox	20 000	240 000	24	26
6AL189	Finettes AL-18 rostfrei	20 000	480 000	24	26



BRADS 20° (IM65AF16 - DC618KB)

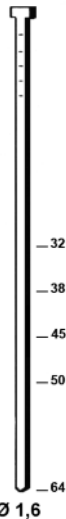

CODE	DESCRIPTION				SEITE
POINTES SANS GAZ :					
PO62750	Brads 20° - 16/32 verzinkt	2 000	12 000	6	
PO62752	Brads 20° - 16/38 verzinkt	2 000	12 000	8	
PO62754	Brads 20° - 16/45 verzinkt	2 000	12 000	9	
PO62756	Brads 20° - 16/50 verzinkt	2 000	12 000	9	
PO62758	Brads 20° - 16/64 verzinkt	2 000	12 000	12	
PO62760	Brads 20° - 16/32 rostfrei	2 000	12 000	6	
PO62762	Brads 20° - 16/38 rostfrei	2 000	12 000	8	
PO62764	Brads 20° - 16/50 rostfrei	2 000	12 000	9	
PO62766	Brads 20° - 16/64 rostfrei	2 000	12 000	12	

CODE	DESCRIPTION				SEITE
+ GAZ :					
PO62340	Pack brads 20° 1,6 x 32 verzinkt	2 000	2	2	
PO62350	Pack brads 20° 1,6 x 38 verzinkt	2 000	2	2	
PO62360	Pack brads 20° 1,6 x 45 verzinkt	2 000	2	2	
PO62370	Pack brads 20° 1,6 x 50 verzinkt	2 000	2	2	
PO62380	Pack brads 20° 1,6 x 64 verzinkt	2 000	2	2	
PO62382	Pack brads 20° 1,6 x 32 rostfrei	2 000	2	2	
PO62384	Pack brads 20° 1,6 x 38 rostfrei	2 000	2	2	
PO62386	Pack brads 20° 1,6 x 50 rostfrei	2 000	2	2	
PO62388	Pack brads 20° 1,6 x 64 rostfrei	2 000	2	2	

GAZ0020 Gaz jaune (30ml)

BE (18 S - S 700 - MP 8 - 8 - 818)



CODE	DESCRIPTION				SEITE
6BE161	BE-16	20 000	360 000	25	
6BE181	BE-18	20 000	360 000	29	



BR (DB - FN)

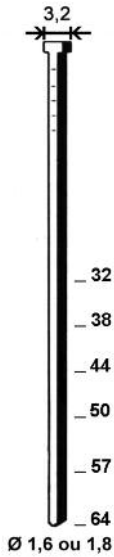

CODE	DESCRIPTION				SEITE
DB - FN 16 (Ø 1,6)					
6BR321	Brads BR-16/32 verzinkt	5 000	20 000	10	
6BR381	Brads BR-16/38 verzinkt	5 000	20 000	13	
6BR441	Brads BR-16/44 verzinkt	5 000	20 000	14	
6BR501	Brads BR-16/50 verzinkt	5 000	20 000	17	
6BR571	Brads BR-16/57 verzinkt	5 000	20 000	18	
6BR641	Brads BR-16/64 verzinkt	5 000	20 000	20	
FN 15 (Ø 1,8)					
6BR322	Brads BR-18/32 verzinkt	3 655	14 620	8	28
6BR382	Brads BR-18/38 verzinkt	3 655	14 620	9	28
6BR442	Brads BR-18/44 verzinkt	3 655	14 620	15	28
6BR502	Brads BR-18/50 verzinkt	3 655	14 620	18	28
6BR572	Brads BR-18/57 verzinkt	3 655	14 620	19	28
6BR642	Brads BR-18/64 verzinkt	3 655	14 620	20	28
6BR449	Brads BR-18/44 rostfrei	3 655	14 620	15	28



DA (NT65AA - 3441 - SFN1 - SFN40 - 32 - DC628KB)

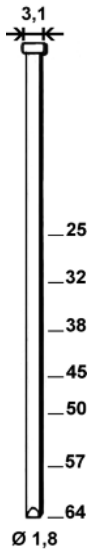

CODE	DESCRIPTION				SEITE
6DA252	Brads DA-25 verzinkt	-	10 000	6	28
6DA322	Brads DA-32 verzinkt	-	10 000	8	28
6DA382	Brads DA-38 verzinkt	-	10 000	9	28
6DA452	Brads DA-45 verzinkt	-	10 000	10	28
6DA502	Brads DA-50 verzinkt	-	10 000	11	28
6DA572	Brads DA-57 verzinkt	-	10 000	12	28
6DA642	Brads DA-64 verzinkt	-	10 000	14	28
6DA258	Brads DA-25 Aluminium	3 780	15 120	6	28
6DA328	Brads DA-32 Aluminium	3 780	15 120	8	28
6DA388	Brads DA-38 Aluminium	3 780	15 120	8	28
6DA458	Brads DA-45 Aluminium	3 780	15 120	8	28
6DA508	Brads DA-50 Aluminium	3 780	15 120	9	28
6DA648	Brads DA-64 Aluminium	3 780	15 120	14	28
6DA389	Brads DA-38 rostfrei	-	10 000	9	28
6DA509	Brads DA-50 rostfrei	-	10 000	11	28
6DA579	Brads DA-57 rostfrei	-	10 000	12	28
6DA649	Brads DA-64 rostfrei	-	10 000	14	28



GA (I - S 100 - P 18 - AZ - 9)

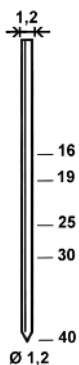

CODE	DESCRIPTION				SEITE
6GA161	GA-16	10 000	100 000	14	27
6GA191	GA-19	10 000	100 000	17	27
6GA251	GA-25	5 000	50 000	14	27
6GA301	GA-30	5 000	50 000	14	27
6GA401	GA-40	5 000	60 000	20	27



J (SKN 12 - TIPIN - SK 300 - BT 13 - 44 - NT45A - 3440 - F 18 - AX - 8)



CODE	DESCRIPTION				SEITE
Ø GAZ :					
6J-101	Minibrads J-10 verzinkt	10 000	100 000	9	14/26
6J-151	Minibrads J-15 verzinkt	10 000	100 000	15	10/14/26/27/29
6J-201	Minibrads J-20 verzinkt	10 000	100 000	19	10/14/26/27/29
6J-251	Minibrads J-25 verzinkt	5 000	100 000	23	10/14/26/27/29
6J-301	Minibrads J-30 verzinkt	5 000	80 000	21	10/14/26/27/29
6J-321	Minibrads J-32 verzinkt	5 000	50 000	14	10/14/26/27
6J-351	Minibrads J-35 verzinkt	5 000	60 000	19	26/27
6J-401	Minibrads J-40 verzinkt	5 000	60 000	22	27
6J-451	Minibrads J-45 verzinkt	5 000	50 000	20	27
6J-501	Minibrads J-50 verzinkt	5 000	50 000	24	
6J-169	Minibrads J-15 rostfrei	10 000	100 000	14	10/14/26/27/29
6J-199	Minibrads J-20 rostfrei	10 000	100 000	18	10/14/26/27/29
6J-259	Minibrads J-25 rostfrei	5 000	50 000	12	10/14/26/27/29
6J-309	Minibrads J-30 rostfrei	5 000	50 000	15	10/14/26/27/29
6J-359	Minibrads J-35 rostfrei	5 000	50 000	16	26/27
6J-409	Minibrads J-40 rostfrei	5 000	50 000	18	27
6J-459	Minibrads J-45 rostfrei	5 000	40 000	18	27
6J-509	Minibrads J-50 rostfrei	5 000	40 000	19	27
6J-167	Minibrads J-15 Aluminium	10 000	100 000	7	10/14/26/27/29
6J-166	Minibrads J-15 Messing	10 000	240 000	38	10/14/26/27/29
6J-198	Minibrads J-20 Messing	10 000	200 000	36	10/14/26/27/29



CODE	DESCRIPTION			SEITE
6J-161BL	Minibrads J-15 verzinkt Blister 1600	20	5	10/14/26/27/29
6J-191BL	Minibrads J-20 verzinkt Blister 1200	20	4	10/14/26/27/29
6J-251BL	Minibrads J-25 verzinkt Blister 1200	20	6	10/14/26/27/29
6J-301BL	Minibrads J-30 verzinkt Blister 1000	20	5	10/14/26/27/29



CODE	DESCRIPTION			SEITE
+ GAZ :				
P6J-101	Pack J-10 verzinkt	2 000	2	2
P6J-151	Pack J-15 verzinkt	2 000	2	2
P6J-201	Pack J-20 verzinkt	2 000	2	2
P6J-251	Pack J-25 verzinkt	2 000	2	2
P6J-301	Pack J-30 verzinkt	2 000	2	2
P6J-321	Pack J-32 verzinkt	2 000	2	2
P6J-351	Pack J-35 verzinkt	2 000	2	2
P6J-401	Pack J-40 verzinkt	2 000	2	2
P6J-451	Pack J-45 verzinkt	2 000	2	2
P6J-501	Pack J-50 verzinkt	2 000	2	2
P6J-169	Pack J-15 rostfrei	2 000	2	2
P6J-199	Pack J-20 rostfrei	2 000	2	2
P6J-259	Pack J-25 rostfrei	2 000	2	2
P6J-309	Pack J-30 rostfrei	2 000	2	2
P6J-359	Pack J-35 rostfrei	2 000	2	2
P6J-409	Pack J-40 rostfrei	2 000	2	2
P6J-459	Pack J-45 rostfrei	2 000	2	2
P6J-509	Pack J-50 rostfrei	2 000	2	2
GAZ0020	Gaz jaune (30ml)			



JA (minitip - MG)

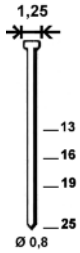

CODE	DESCRIPTION				SEITE
6JA131	JA-13	20 000	200 000	12	
6JA161	JA-16	20 000	200 000	16	
6JA191	JA-19	20 000	200 000	18	
6JA251	JA-25	10 000	100 000	12	



JM (AY)

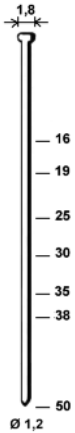

CODE	DESCRIPTION				SEITE
6JM161	JM-16 verzinkt	10 000	100 000	16	
6JM191	JM-19 verzinkt	10 000	100 000	18	
6JM251	JM-25 verzinkt	5 000	50 000	12	
6JM301	JM-30 verzinkt	5 000	50 000	14	
6JM351	JM-35 verzinkt	5 000	50 000	16	
6JM401	JM-38 verzinkt	5 000	50 000	19	
6JM501	JM-50 verzinkt	4 000	40 000	17	
6JM259	JM-25 rostfrei	5 000	50 000	12	
6JM309	JM-30 rostfrei	5 000	50 000	16	

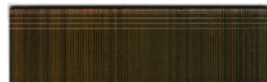

N (SKN 16 - TIP - SK 400 - NT65A - 60 - F 16 - 16)

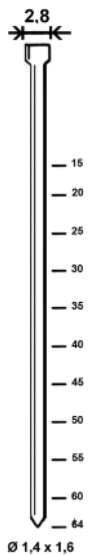

CODE	DESCRIPTION				SEITE
6N-151	Brads N-15 verzinkt	4 000	80 000	20	
6N-201	Brads N-20 verzinkt	4 000	80 000	26	27
6N-251	Brads N-25 verzinkt	4 000	64 000	26	27
6N-301	Brads N-30 verzinkt	4 000	48 000	15	27
6N-351	Brads N-35 verzinkt	4 000	48 000	28	27
6N-401	Brads N-40 verzinkt	4 000	32 000	21	27
6N-451	Brads N-45 verzinkt	4 000	32 000	23	27
6N-501	Brads N-50 verzinkt	4 000	32 000	25	27
6N-551	Brads N-55 verzinkt	4 000	32 000	27	27
6N-601	Brads N-60 verzinkt	4 000	32 000	31	27
6N-641	Brads N-64 verzinkt	4 000	32 000	32	27
6N-259	Brads N-25 rostfrei	5 000	60 000	25	27
6N-309	Brads N-30 rostfrei	5 000	30 000	15	27
6N-359	Brads N-35 rostfrei	2 500	30 000	17	27
6N-409	Brads N-40 rostfrei	2 500	30 000	19	27
6N-459	Brads N-45 rostfrei	2 500	30 000	22	27
6N-509	Brads N-50 rostfrei	2 500	30 000	24	27



ND (SKN 20 - SK 500 - F 14)

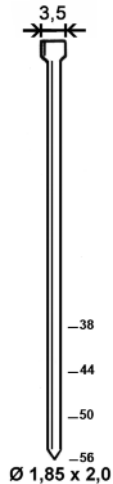

CODE	DESCRIPTION				SEITE
6ND381	Brads ND-38 verzinkt	2 500	10 000	10	
6ND441	Brads ND-44 verzinkt	2 500	10 000	13	
6ND501	Brads ND-50 verzinkt	2 500	10 000	14	
6ND561	Brads ND-56 verzinkt	2 500	15 000	23	

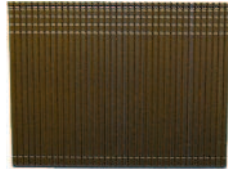

SD (AP - PIN 562 - SPIN - 12)

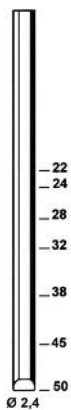

CODE	DESCRIPTION				SEITE
6SD221	SD-22 Aluminium	5 000	15 000	5	28
6SD241	SD-24 Aluminium	5 000	15 000	6	28
6SD281	SD-28 Aluminium	5 000	15 000	7	28
6SD321	SD-32 Aluminium	5 000	15 000	8	28
6SD381	SD-38 Aluminium	5 000	10 000	6	28
6SD451	SD-45 Aluminium	2 500	10 000	7	28
6SD501	SD-50 Aluminium	2 500	10 000	8	28

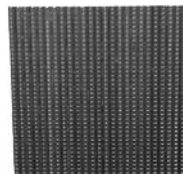

T (TN 22 - N 12 - 3419 - M2T - M3T)

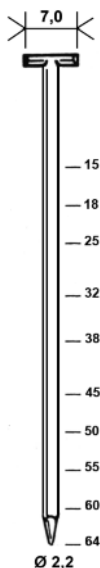

CODE	DESCRIPTION				SEITE
6T-322	T-32 verzinkt	10 000	600 000	600	12/27
6T-382	T-38 verzinkt	10 000	600 000	702	12/27
6T-452	T-45 verzinkt	10 000	600 000	840	12/27
6T-502	T-50 verzinkt	10 000	400 000	720	12/27
6T-552	T-55 verzinkt	10 000	400 000	680	12/27
6T-602	T-60 verzinkt	10 000	400 000	720	12/27
6T-642	T-64 verzinkt	10 000	400 000	760	12/27
6T-152	T-15 Stahl verzinkt	20 000	600 000	312	
6T-182	T-18 Stahl verzinkt	20 000	600 000	402	
6T-252	T-25 Stahl verzinkt	20 000	600 000	480	27

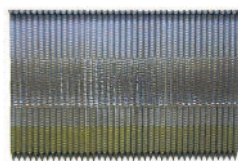



COILS MINI SHEET



CODE	DESCRIPTION				SEITE
CN 238					
MS180225	Coils Mini Sheet 18 x 22 glatt verzinkt HDG	12 800	460 800	300	
MS180255	Coils Mini Sheet 18 x 25 glatt verzinkt HDG	11 200	403 200	282	
MS180258	Coils Mini Sheet 18 x 25 Rille rostfrei LK	11 200	403 200	282	

LK = Linsenkopf

COILS SHEET

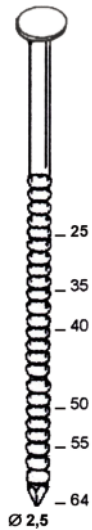

CODE	DESCRIPTION				SEITE
VERZINKT 50µm (HDG)					
16S25256	Coils Sheet 25 x 25 Rille HDG*	3 000	144 000	216	
ROSTFREI A2					
16S25259	Coils Sheet 25 x 25 Rille rostfrei*	3 600	144 000	181	
16S25359	Coils Sheet 25 x 35 Rille rostfrei*	2 000	144 000	265	30
ROSTFREI A4					
16S25408	Coils Sheet 25 x 40 Rille rostfrei LK	7 200	194 400	331	30
16S25508	Coils Sheet 25 x 50 Rille rostfrei LK	6 000	162 000	371	30
16S25558	Coils Sheet 25 x 55 Rille rostfrei LK	6 000	162 000	389	30
16S25648	Coils Sheet 25 x 64 Rille rostfrei LK	4 800	129 600	478	30

LK = Linsenkopf

Ø ≈ 5,5 mm

* Ø 6,5 mm

ROOFING (CR - RBW - 3520 - 3175 - 3145 - SCN 50 R)

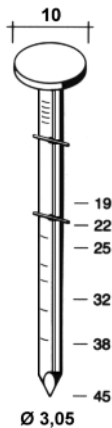

CODE	DESCRIPTION				SEITE
VERZINKT 50µm (HDG)					
R163019G	Coils 3,05 x 19 HDG	7 200	216 000	216	29
R163022G	Coils 3,05 x 22 HDG	7 200	216 000	333	29
R163025G	Coils 3,05 x 25 HDG	7 200	216 000	361	29
R163032G	Coils 3,05 x 32 HDG	7 200	216 000	430	29
R163038G	Coils 3,05 x 38 HDG	7 200	216 000	529	29
R163045G	Coils 3,05 x 45 HDG	7 200	216 000	609	29
ROSTFREI A2					
R1630259	Coils 3,05 x 25 rostfrei	7 200	216 000	361	29



COILS BO (CN 57 - CN 55)

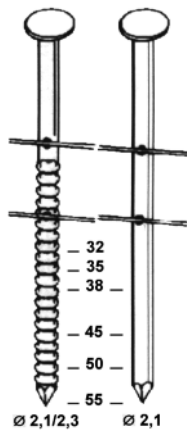

CODE	DESCRIPTION				SEITE
GLATT					
BO-21381	Coils BO 21 x 38 glatt	19 500	546 000	590	31
BO-21451	Coils BO 21 x 45 glatt	15 600	436 800	555	31
BO-21501	Coils BO 21 x 50 glatt	15 600	436 800	616	31
BO-21551	Coils BO 21 x 55 glatt	11 700	327 600	537	31
RILLE					
BO-21322	Coils BO 21/23 x 32 Rille	23 400	655 200	590	31
BO-21352	Coils BO 21/23 x 35 Rille	19 500	546 000	546	31
BO-21382	Coils BO 21/23 x 38 Rille	19 500	546 000	617	31
BO-21452	Coils BO 21/23 x 45 Rille	15 600	436 800	555	31
BO-21502	Coils BO 21/23 x 50 Rille	15 600	436 800	616	31
BO-21552	Coils BO 21/23 x 55 Rille	11 700	327 600	501	31
RILLE VERZINKT 12µm					
BO-21386	Coils BO 21/23 x 38 Rille verzinkt	19 500	546 000	590	31
BO-21456	Coils BO 21/23 x 45 Rille verzinkt	15 600	436 800	555	31
BO-21506	Coils BO 21/23 x 50 Rille verzinkt	15 600	436 800	616	31
BO-21556	Coils BO 21/23 x 55 Rille verzinkt	11 700	327 600	560	31
ROSTFREI					
BO-21358	Coils BO 21/23 x 35 Rille rostfrei LK	19 500	546 000	546	31
BO-21458	Coils BO 21/23 x 45 Rille rostfrei LK	10 800	324 000	415	31
BO-21558	Coils BO 21/23 x 55 Rille rostfrei LK	7 200	216 000	361	31

LK = Linsenkopf

COILS 21 (ROLL 50 - ROLL 60 - BDC - NV 50 - SCN 50)

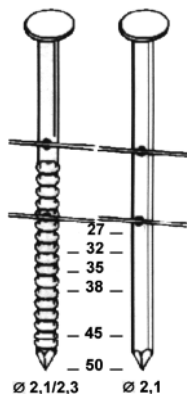

CODE	DESCRIPTION				SEITE
GLATT					
16C21271	Coils 21 x 27 glatt	25 200	705 600	557	
16C21321	Coils 21 x 32 glatt	21 000	588 000	541	29
16C21381	Coils 21 x 38 glatt	16 800	470 400	508	29
16C21451	Coils 21 x 45 glatt	16 800	470 400	597	29
16C21501	Coils 21 x 50 glatt	12 600	352 800	498	29
RILLE					
16C21322	Coils 21/23 x 32 Rille	21 000	588 000	529	29
16C21352	Coils 21/23 x 35 Rille	21 000	588 000	641	29
16C21382	Coils 21/23 x 38 Rille	16 800	470 400	602	29
16C21452	Coils 21/23 x 45 Rille	16 800	470 400	602	29
16C21502	Coils 21/23 x 50 Rille	12 600	352 800	498	29
RILLE VERZINKT 12µm					
16C21326	Coils 21/23 x 32 Rille verzinkt	21 000	588 000	541	29
16C21386	Coils 21/23 x 38 Rille verzinkt	16 800	470 400	513	29
16C21456	Coils 21/23 x 45 Rille verzinkt	16 800	504 000	645	29
16C21506	Coils 21/23 x 50 Rille verzinkt	12 600	352 800	498	29
ROSTFREI LK					
16C21358	Coils 21/23 x 35 Rille rostfrei LK	21 000	588 000	670	29
16C21458	Coils 21/23 x 45 Rille rostfrei LK	16 800	470 400	602	29
16C21508	Coils 21/23 x 50 Rille rostfrei LK	12 600	352 800	540	29

LK = Linsenkopf

COILS 23-25-28-31-34 (ROLL 85 - BDC - N 70 - N 80 - NV 83 A - SCN 65)

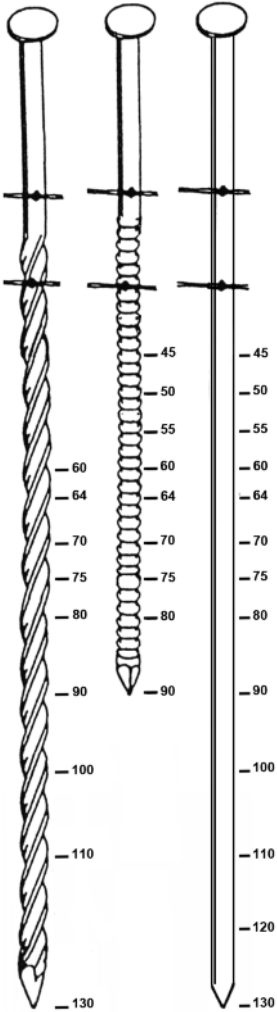

CODE	DESCRIPTION				SEITE
GLATT					
16F23451	Coils 23 x 45 glatt	10 800	324 000	496	30/31
16F23501	Coils 23 x 50 glatt	9 000	270 000	459	30/31
16F23551	Coils 23 x 55 glatt	9 000	270 000	535	30/31/32
16F25601	Coils 25 x 60 glatt	9 000	270 000	648	30/31/32
16F25641	Coils 25 x 64 glatt	7 200	216 000	549	30/31/32
16F28641	Coils 28 x 64 glatt	6 000	180 000	486	30/31/32
16F25681	Coils 25 x 70 glatt	7 200	216 000	581	30/31/32
16F28681	Coils 28 x 70 glatt	6 000	180 000	608	30/31/32
16F31701	Coils 31 x 70 glatt	6 000	180 000	765	30/31/32
16F28751	Coils 28 x 75 glatt	6 000	180 000	670	30/31/32
16F28801	Coils 28 x 80 glatt	4 500	135 000	535	30/31/32
16F31801	Coils 31 x 80 glatt	4 500	135 000	656	30/31/32
16F31881	Coils 31 x 90 glatt	4 500	135 000	720	30/32
16F34981	Coils 34 x 100 glatt	3 600	108 000	638	32
16381101	Coils 38 x 110 glatt	1 200	36 000	373	32
16381201	Coils 38 x 120 glatt	1 200	36 000	391	32
16381301	Coils 38 x 130 glatt	1 200	36 000	415	32
GLATT VERZINKT 12µm					
16F23555	Coils 23 x 55 glatt verzinkt	9 000	270 000	502	30/31/32
16F25645	Coils 25 x 64 glatt verzinkt	7 200	216 000	549	30/31/32
16F28685	Coils 28 x 70 glatt verzinkt	6 000	180 000	608	30/31/32
RILLE					
16F23452	Coils 23/25 x 45 Rille	10 800	324 000	496	30/31
16F23502	Coils 23/25 x 50 Rille	9 000	270 000	459	30/31
16F23552	Coils 23/25 x 55 Rille	9 000	270 000	502	30/31/32
16F25602	Coils 25/27 x 60 Rille	9 000	270 000	545	30/31/32
16F25642	Coils 25/27 x 64 Rille	7 200	216 000	549	30/31/32
16F25682	Coils 25/27 x 70 Rille	7 200	216 000	581	30/31/32
16F28752	Coils 28/31 x 75 Rille	6 000	180 000	670	30/31/32
16F28802	Coils 28/31 x 80 Rille	4 500	135 000	535	30/31/32
16F31882	Coils 31/34 x 90 Rille	4 500	135 000	720	30/32
RILLE VERZINKT 12µm					
16F23456	Coils 23/25 x 45 Rille verzinkt	10 800	324 000	496	30/31
16F23506	Coils 23/25 x 50 Rille verzinkt	9 000	270 000	459	30/31
16F23556	Coils 23/25 x 55 Rille verzinkt	9 000	270 000	518	30/31/32
16F25606	Coils 25/27 x 60 Rille verzinkt	9 000	270 000	643	30/31/32
16F25646	Coils 25/27 x 64 Rille verzinkt	7 200	216 000	568	30/31/32
16F25686	Coils 25/27 x 70 Rille verzinkt	7 200	216 000	581	30/31/32
16F28806	Coils 28/31 x 80 Rille verzinkt	4 500	135 000	466	30/31/32
16F31886	Coils 31/34 x 90 Rille verzinkt	4 500	135 000	720	30/32
RILLE ROSTFREI A2					
16F25458	Coils 25/27 x 45 Rille rostfrei LK	10 800	324 000	599	30/31
16F25509	Coils 25/27 x 50 Rille rostfrei	9 000	270 000	559	30/31
16F25558	Coils 25/27 x 55 Rille rostfrei LK	7 200	216 000	469	30/31/32
16F25649	Coils 25/27 x 64 Rille rostfrei	7 200	216 000	745	30/31/32
16F25648	Coils 25/27 x 64 Rille rostfrei LK	7 200	216 000	747	30/31/32
16F28808	Coils 28/31 x 80 Rille rostfrei LK	4 500	135 000	551	30/31/32
SCHRAUB					
16F25603	Coils 25 x 60 schraub	9 000	270 000	562	30/31/32
16F25643	Coils 25 x 64 schraub	7 200	216 000	477	30/31/32
16F25683	Coils 25 x 70 schraub	7 200	216 000	547	30/31/32
16F28683	Coils 28 x 70 schraub	6 000	180 000	529	30/31/32
16F28753	Coils 28 x 75 schraub	4 500	135 000	436	30/31/32
16F28803	Coils 28 x 80 schraub	4 500	135 000	464	30/31/32
16F31883	Coils 31 x 90 schraub	4 500	135 000	626	30/32
16F34984	Coils 34 x 100 schraub	3 600	108 000	638	32
16381103	Coils 38 x 110 schraub	1 200	36 000	366	32
16381303	Coils 38 x 130 schraub	1 200	36 000	415	32
SCHRAUB VERZINKT 12µm					
16F28807	Coils 28 x 80 schraub verzinkt	4 500	135 000	466	30/31/32
16F31887	Coils 31 x 90 schraub verzinkt	4 500	135 000	594	30/32
16F34987	Coils 34 x 100 schraub verzinkt	3 600	108 000	638	32
16381307	Coils 38 x 130 schraub verzinkt	1 200	36 000	415	32

LK = Linsenkopf

20° (KN - RN)

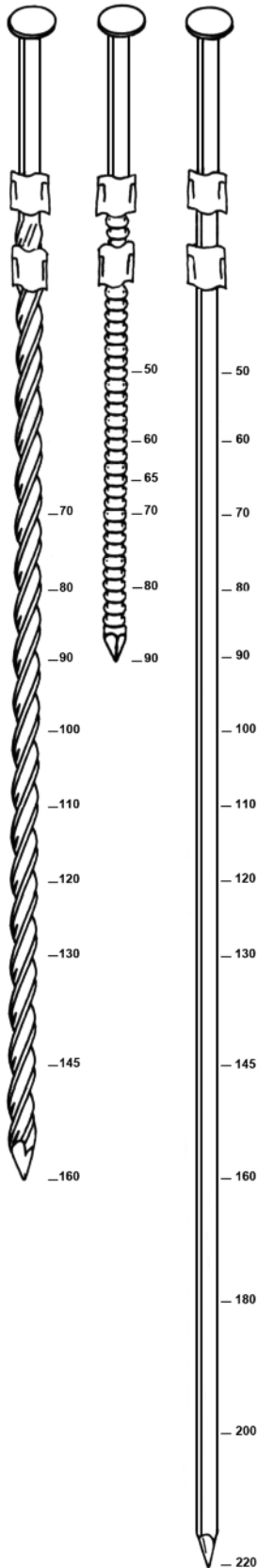

CODE	DESCRIPTION				SEITE
GLATT					
20290501	20° 29 x 50 glatt	2 200	264 000	713	33
20290601	20° 29 x 60 glatt	2 200	264 000	837	33
20290701	20° 29 x 70 glatt	2 200	264 000	958	33
20310801	20° 31 x 80 glatt	2 200	165 000	809	33
20310901	20° 31 x 90 glatt	2 200	165 000	896	33
20381001	20° 38 x 100 glatt	2 000	96 000	864	33
20381101	20° 38 x 110 glatt	1 400	67 200	672	33
20381201	20° 38 x 120 glatt	1 400	67 200	720	33
20381301	20° 38 x 130 glatt	1 400	67 200	768	33
20461451	20° 46 x 145 glatt	500	37 500	714	33
20461601	20° 46 x 160 glatt	500	37 500	788	33
20501801	20° 50 x 180 glatt	440	35 200	845	
20462001	20° 50 x 200 glatt	440	35 200	975	
20462201	20° 50 x 220 glatt	440	35 200	999	
RILLE					
20290502	20° 29 x 50 Rille	2 200	264 000	713	33
20290602	20° 29 x 60 Rille	2 200	264 000	837	33
20290702	20° 29 x 70 Rille	2 200	264 000	958	33
20310802	20° 31 x 80 Rille	2 200	165 000	800	33
RILLE VERZINKT 12µm					
20290506	20° 29 x 50 Rille verzinkt	2 200	264 000	713	33
20290606	20° 29 x 60 Rille verzinkt	2 200	264 000	837	33
20290706	20° 29 x 70 Rille verzinkt	2 200	264 000	958	33
20310806	20° 31 x 80 Rille verzinkt	2 200	165 000	809	33
20310906	20° 31 x 90 Rille verzinkt	2 200	165 000	896	33
RILLE ROSTFREI A2					
20290508	20° 29 x 50 Rille rostfrei LK	2 200	264 000	713	33
20290659	20° 29 x 65 Rille rostfrei	2 200	264 000	913	33
20290658	20° 29 x 65 Rille rostfrei LK	2 200	264 000	913	33
VIERKANT					
20290703	20° 29 x 70 vierkant	2 200	264 000	958	33
20310803	20° 31 x 80 vierkant	2 200	165 000	807	33
20310903	20° 31 x 90 vierkant	2 200	165 000	896	33
20381003	20° 38 x 100 vierkant	1 600	96 000	751	33
20381103	20° 38 x 110 vierkant	1 500	90 000	774	33
20381203	20° 38 x 120 vierkant	1 400	84 000	787	33
20381303	20° 38 x 130 vierkant	1 200	72 000	730	33
20461453	20° 46 x 145 vierkant	500	30 000	496	33
20461603	20° 46 x 160 vierkant	500	30 000	548	33
VIERKANT VERZINKT 12µm					
20381007	20° 38 x 100 vierkant verzinkt	1 600	96 000	752	33
20381307	20° 38 x 130 vierkant verzinkt	1 200	72 000	730	33
20461457	20° 46 x 145 vierkant verzinkt	500	30 000	496	33
20461607	20° 46 x 160 vierkant verzinkt	500	30 000	548	33

LK = Linsenkopf

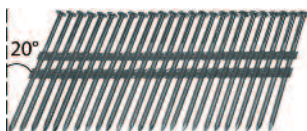

PACK 20° + GAZ

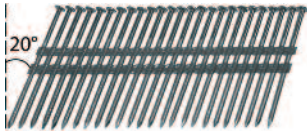
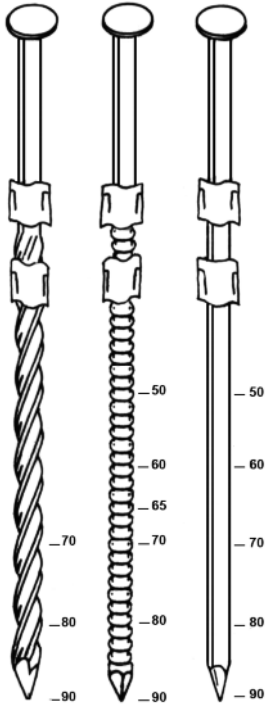

CODE	DESCRIPTION				SEITE
GLATT					
P2029501	Pack 20° 29 x 50 glatt	2 200	2	6	
P2029601	Pack 20° 29 x 60 glatt	2 200	2	7	
P2029701	Pack 20° 29 x 70 glatt	2 200	2	8	
P2031801	Pack 20° 31 x 80 glatt	2 200	2	11	
P2031901	Pack 20° 31 x 90 glatt	2 200	2	12	
RILLE					
P2029502	Pack 20° 29 x 50 Rille	2 200	2	6	
P2029602	Pack 20° 29 x 60 Rille	2 200	2	7	
P2029702	Pack 20° 29 x 70 Rille	2 200	2	8	
P2031802	Pack 20° 31 x 80 Rille	2 200	2	11	
RILLE VERZINKT 12µm					
P2029506	Pack 20° 29 x 50 Rille verzinkt	2 200	2	6	
P2029606	Pack 20° 29 x 60 Rille verzinkt	2 200	2	7	
P2029706	Pack 20° 29 x 70 Rille verzinkt	2 200	2	9	
P2031806	Pack 20° 31 x 80 Rille verzinkt	2 200	2	11	
P2031906	Pack 20° 31 x 90 Rille verzinkt	2 200	2	12	
RILLE ROSTFREI A2					
P2029508	Pack 20° 29 x 50 Rille rostfrei LK	2 200	2	6	
P2029659	Pack 20° 29 x 65 Rille rostfrei	2 200	2	8	
P2029658	Pack 20° 29 x 65 Rille rostfrei LK	2 200	2	8	
VIERKANT					
P2029703	Pack 20° 29 x 70 vierkant	2 200	2	9	
P2031803	Pack 20° 31 x 80 vierkant	2 200	2	12	
P2031903	Pack 20° 31 x 90 vierkant	2 200	2	12	
GAZ0010	Gaz bois Trak-It W3 (IM 350)				

LK = Linsen Kopf

34° (Senco D - Paslode - 50)

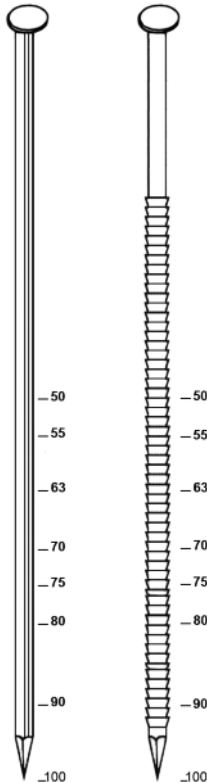

CODE	DESCRIPTION				PAGE
GLATT					
34280501	34° 28 x 50 glatt	2 200	264 000	676	34
34280551	34° 28 x 55 glatt	2 200	264 000	745	34
34280631	34° 28 x 63 glatt	2 200	264 000	853	34
34280701	34° 28 x 70 glatt	2 200	264 000	948	34
34280751	34° 28 x 75 glatt	2 200	264 000	999	34
34280801	34° 28 x 80 glatt	2 200	165 000	677	34
34310901	34° 31 x 90 glatt	2 200	165 000	891	34
GLATT VERZINKT 12µm					
34280705	34° 28 x 70 glatt verzinkt	2 200	264 000	948	34
34310905	34° 31 x 90 glatt verzinkt	2 200	165 000	891	34
34311005	34° 31 x 100 glatt verzinkt	2 200	165 000	999	34
RILLE					
34280502	34° 28 x 50 Rille	2 200	264 000	676	34
34280632	34° 28 x 63 Rille	2 200	264 000	853	34
34280702	34° 28 x 70 Rille	2 200	264 000	948	34
34280752	34° 28 x 75 Rille	2 200	264 000	999	34
34280802	34° 28 x 80 Rille	2 200	165 000	677	34
34310902	34° 31 x 90 Rille	2 200	165 000	891	34
RILLE VERZINKT 12µm					
34280506	34° 28 x 50 Rille verzinkt	2 200	264 000	676	34
34280556	34° 28 x 55 Rille verzinkt	2 200	264 000	745	34
34280636	34° 28 x 63 Rille verzinkt	2 200	264 000	853	34
34280706	34° 28 x 70 Rille verzinkt	2 200	264 000	948	34
34280756	34° 28 x 75 Rille verzinkt	2 200	264 000	999	34
34280806	34° 28 x 80 Rille verzinkt	2 200	165 000	677	34
34310906	34° 31 x 90 Rille verzinkt	2 200	165 000	891	34
34311006	34° 31 x 100 Rille verzinkt	2 200	165 000	999	34
RILLE HDG 50µm					
34280507	34° 28 x 50 Rille HDG	2 200	264 000	705	34
34280637	34° 28 x 63 Rille HDG	2 200	264 000	853	34
34280757	34° 28 x 75 Rille HDG	2 200	264 000	999	34
34310907	34° 31 x 90 Rille HDG	2 200	165 000	891	34
RILLE ROSTFREI A2					
34280509	34° 28 x 50 Rille rostfrei	2 200	264 000	676	34
34280558	34° 28 x 55 Rille rostfrei LK	2 200	264 000	745	34
34280639	34° 28 x 63 Rille rostfrei	2 200	264 000	853	34
34280708	34° 28 x 70 Rille rostfrei LK	2 200	264 000	948	34
34310909	34° 31 x 90 Rille rostfrei	2 200	165 000	891	34

LK = Linsenkopf

PACK 34° + GAZ (IM350 - NR90GC - GS690CH)

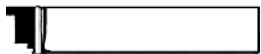
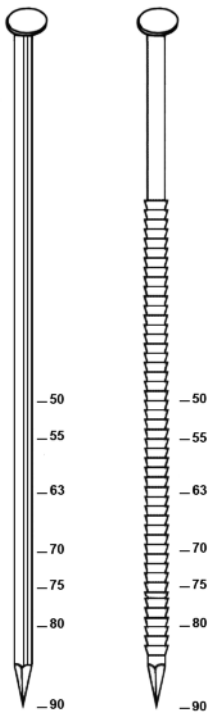

CODE	DESCRIPTION				PAGE
GLATT					
P3428501	Pack 34° 28 x 50 glatt	2 200	2	6	35
P3428551	Pack 34° 28 x 55 glatt	2 200	2	6	35
P3428631	Pack 34° 28 x 63 glatt	2 200	2	7	35
P3428701	Pack 34° 28 x 70 glatt	2 200	2	8	35
P3428751	Pack 34° 28 x 75 glatt	2 200	2	9	35
P3428801	Pack 34° 28 x 80 glatt	2 200	2	9	35
P3431901	Pack 34° 31 x 90 glatt	2 200	2	12	35
GLATT VERZINKT 12µm					
P3428705	Pack 34° 28 x 70 glatt verzinkt	2 200	2	8	35
P3431905	Pack 34° 31 x 90 glatt verzinkt	2 200	2	12	35
RILLE					
P3428502	Pack 34° 28 x 50 Rille	2 200	2	6	35
P3428632	Pack 34° 28 x 63 Rille	2 200	2	7	35
P3428702	Pack 34° 28 x 70 Rille	2 200	2	8	35
P3428752	Pack 34° 28 x 75 Rille	2 200	2	9	35
P3428802	Pack 34° 28 x 80 Rille	2 200	2	9	35
P3431902	Pack 34° 31 x 90 Rille	2 200	2	12	35
RILLE VERZINKT 12µm					
P3428506	Pack 34° 28 x 50 Rille verzinkt	2 200	2	6	35
P3428556	Pack 34° 28 x 55 Rille verzinkt	2 200	2	6	35
P3428636	Pack 34° 28 x 63 Rille verzinkt	2 200	2	7	35
P3428706	Pack 34° 28 x 70 Rille verzinkt	2 200	2	8	35
P3428756	Pack 34° 28 x 75 Rille verzinkt	2 200	2	9	35
P3428806	Pack 34° 28 x 80 Rille verzinkt	2 200	2	9	35
P3431906	Pack 34° 31 x 90 Rille verzinkt	2 200	2	11	35
RILLE HDG 50µm					
P3428507	Pack 34° 28 x 50 Rille HDG	2 200	2	6	35
P3428637	Pack 34° 28 x 63 Rille HDG	2 200	2	7	35
P3428757	Pack 34° 28 x 75 Rille HDG	2 200	2	9	35
P3431907	Pack 34° 31 x 90 Rille HDG	2 200	2	11	35
RILLE ROSTFREI A2					
P3428509	Pack 34° 28 x 50 Rille rostfrei	2 200	2	6	35
P3428558	Pack 34° 28 x 55 Rille rostfrei LK	2 200	2	6	35
P3428639	Pack 34° 28 x 63 Rille rostfrei	2 200	2	7	35
P3428708	Pack 34° 28 x 70 Rille rostfrei LK	2 200	2	8	35
P3431909	Pack 34° 31 x 90 Rille rostfrei	2 200	2	12	35

GAZ0010 Gaz bois Trak-It W3 (IM 350)

LK = Linsen Kopf



SCRAIL® FasCoat™



CODE	DESCRIPTION				PAGE
16S2835FS	Scrail® 28/32 x 35 FasCoat™ PH	8 400	226 800	481	30
16S2845FS	Scrail® 28/32 x 45 FasCoat™ PH	7 200	194 400	428	30
16S2550FSB	Scrail® 25/28 x 50 FasCoat™ PH noir	6 000	162 000	405	30
16S2550FSR	Scrail® 25/28 x 50 FasCoat™ PH rouge	6 000	162 000	405	30
16S2857FS	Scrail® 28/32 x 57 FasCoat™ PH	4 800	129 600	428	30
16S2865FS	Scrail® 28/32 x 65 FasCoat™ PH	4 800	129 600	480	30
16S2875FS	Scrail® 28/32 x 75 FasCoat™ PH	4 800	129 600	544	30

Innendurchmesser 2,8 mm. Außendurchmesser 3,1 mm.
Für große Werte von Zugfestigkeit.

NAGELTECHNIK Haftennägel

JDB 20° (3554)



CODE	DESCRIPTION				PAGE
ROSTFREI A2					
20250259	Pointes JDB 20° 25 x 25 Rille rostfrei	2 000	364 000	382	
20250359	Pointes JDB 20° 25 x 35 Rille rostfrei	2 000	364 000	510	
RILLE HDG 50µm					
20250256	Pointes JDB 20° 25 x 25 Rille HDG	2 000	364 000	419	
20250356	Pointes JDB 20° 25 x 35 Rille HDG	2 000	364 000	557	



ANKER VERZINKT 12µm

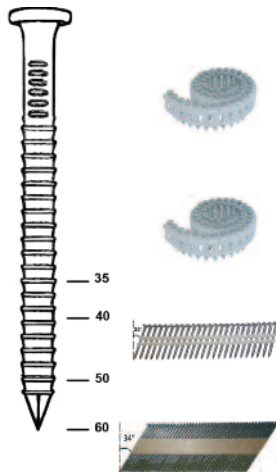

CODE	DESCRIPTION				PAGE
MAX - CNV 300 J (livrable jusqu'à épauement du stock)					
MAX4040G	Coils 40 x 40 Rille verzinkt	3 600	108 000	447	
MAX4050G	Coils 40 x 50 Rille verzinkt	2 400	72 000	370	
MAX4060G	Coils 40 x 60 Rille verzinkt	2 400	72 000	440	
ALSAFIX C 41/65 P1 - MAX HN 65 J					
MAX4135G	Coils 41 x 35 Rille verzinkt	2 000	120 000	438	
MAX4140G	Coils 41 x 40 Rille verzinkt	2 000	80 000	332	34
MAX4150G	Coils 41 x 50 Rille verzinkt	2 000	80 000	410	34
MAX4160G	Coils 41 x 60 Rille verzinkt	2 000	80 000	488	34
ALSAFIX F 40/60 P1 - Haubold RN 60 PII/BS 4.0 - HH 3521					
20400406	25° 40 x 40 Rille verzinkt	2 000	120 000	484	34
20400506	25° 40 x 50 Rille verzinkt	2 000	120 000	582	34
20400606	25° 40 x 60 Rille verzinkt	2 000	120 000	726	34
Paslode BS1 - Senco MC60-34 - Bostitch MCN 38					
34400356	34° 40 x 35 Rille verzinkt	2 200	264 000	1 064	
34400406	34° 40 x 40 Rille verzinkt	2 200	264 000	1 135	
34400506	34° 40 x 50 Rille verzinkt	2 200	264 000	1 420	

CODE	DESCRIPTION				PAGE
Pack für F 40/65 G1					
P3440356	Pack 34° 40 x 35 Rille verzinkt	2 200	2	9	35
P3440406	Pack 34° 40 x 40 Rille verzinkt	2 200	2	11	35
P3440506	Pack 34° 40 x 50 Rille verzinkt	2 200	2	12	35



Schrauber	56
Schrauben	58

T65304



CODE	DIM.	R	€/1
T65304	25 - 55 mm	B	550,00

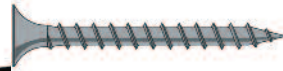
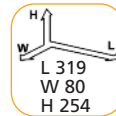

Schrauben ohne Magazin



Streifenschrauben mit Magazin

EA2302



CODE	DIM.	R	€/1
EA2302	25 - 55 mm	B	237,00

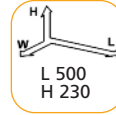

Schrauben ohne Magazin



Streifenschrauben mit Magazin

SCHNELLBAUSCHRAUBEN PHOS. MAGAZINIERT

T65304 & EA2302

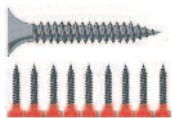

CODE	DESCRIPTION				R
10039025	3,9 x 25 - Phillips PH2	1 000	180 000	279	C
10039035	3,9 x 35 - Phillips PH2	1 000	180 000	392	C
10039045	3,9 x 45 - Phillips PH2	1 000	180 000	504	C

SCHNELLBAUSCHRAUBEN GALV. MAGAZINIERT

T65304 & EA2302

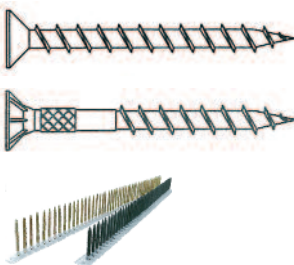

CODE	DESCRIPTION				R
10440025	4,0 x 25 - PZ2 *	1 000	195 000	291	C
10440030	4,0 x 30 - PZ2 *	1 000	195 000	349	C
10440035	4,0 x 35 - PZ2 **	1 000	195 000	406	C
10440040	4,0 x 40 - PZ2 **	1 000	195 000	464	C
10440045	4,0 x 45 - PZ2 **	1 000	195 000	523	C
10440050	4,0 x 50 - PZ2 **	1 000	130 000	387	C
10440055	4,0 x 55 - PZ2 **	1 000	130 000	533	C

* Vollgewinde ** Teilgewinde

→ **HH 80 B**



CODE	DIM.	R	€/1
MSC80A	40 - 80 mm Ø 4,5 - 5,0 mm - M6	B	1 760,00



Schrauben in Rolle

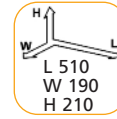

→ **ALCHOC740**



CODE	R	€/1
12IT250	B	220,00

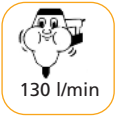
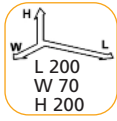

→ **ALCHOC325**



CODE	R	€/1
12ISD009	B	265,00

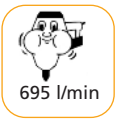
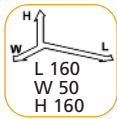



HOLZ SCHRAUBE VERZINKT

HH 80 B

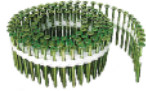
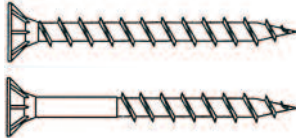

CODE	DESCRIPTION			
SP4025TX	4,0 x 25 verzinkt TX20 *	1 000	144 000	245
SP4030TX	4,0 x 30 verzinkt TX20 *	1 000	144 000	258
SP4035TX	4,0 x 35 verzinkt TX20 **	1 000	144 000	300
SP4040TX	4,0 x 40 verzinkt TX20 **	1 000	144 000	343
SP4045TX	4,0 x 45 verzinkt TX20 **	1 000	144 000	386
SP4050TX	4,0 x 50 verzinkt TX20 **	1 000	144 000	429
SP4550TX	4,5 x 50 verzinkt TX20 **	750	108 000	412
SP4555TX	4,5 x 55 verzinkt TX20 **	750	108 000	443
SP5060TX	5,0 x 60 verzinkt TX25 **	750	108 000	581
SP5065TX	5,0 x 65 verzinkt TX25 **	390	56 160	271
SP5070TX	5,0 x 70 verzinkt TX25 **	390	56 160	376
SP5080TX	5,0 x 80 verzinkt TX25 **	390	56 160	334

* Vollgewinde ** Teilgewinde

SP5040PZ Vis 5,0 x 40 verzinkt PZ *
VMZ von VM ZINC®

GIBSPLETTENSCHRAUBEN



CODE	DESCRIPTION			
GP3925	3,9 x 25 phosphatiert - PH2	1 000	144 000	223
GP3935	3,9 x 35 phosphatiert - PH2	1 000	144 000	314
GP3945	3,9 x 45 phosphatiert - PH2	1 000	144 000	403
GP3955	3,9 x 55 phosphatiert - PH2	1 000	144 000	493

HOLZ INOX

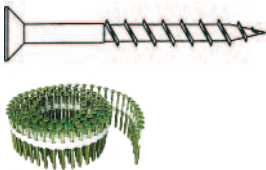

CODE	DESCRIPTION			
SP4025A2	Vis 4,0 x 25 Inox TX20	1 000	144 000	268
SP4030A2	Vis 4,0 x 30 Inox TX20	1 000	144 000	305
SP4035A2	Vis 4,0 x 35 Inox TX20	1 000	144 000	375
SP4040A2	Vis 4,0 x 40 Inox TX20	1 000	144 000	429
SP4050A2	Vis 4,0 x 50 Inox TX20	1 000	144 000	429

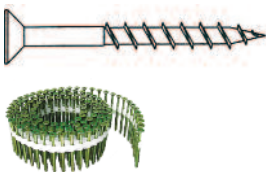

HOLZ INOX

HH 80 B



CODE	DESCRIPTION			
BDS550A2	- 4,5 x 50 Inox A2 Bohrspitze TX20	750	108 000	400
BDS560A2	- 5,0 x 60 Inox A2 Bohrspitze TX25	750	108 000	605
BDS570A2	- 5,0 x 70 Inox A2 Bohrspitze TX25	390	56 160	378
BDS580A2	- 5,0 x 80 Inox A2 Bohrspitze TX25	390	56 160	334

SCHRAUBEN BITS

CODE	DESCRIPTION			
134H060	Magnetischer Bithalter 1/4"	1	10	3
PH2501	PH-1	5	100	10
PH2502	PH-2	5	100	10
PH2503	PH-3	5	100	10
PZ2501	PZ-1	5	100	10
PZ2502	PZ-2	5	100	10
PZ2503	PZ-3	5	100	10
PZ2504	PZ-4	5	100	10
TX2510	TX10	5	100	10
TX2515	TX15	5	100	10
TX2520	TX20	5	100	10
TX2525	TX25	5	100	10
TX2530	TX30	5	100	10
TX2540	TX40	5	100	10

BIT SORTIMENT



CODE	R	€/1
134BIT80	C	52,00

Inhalt :

- 80 Bit 25 mm
- 1 Bithalter

SCHRAUBEN Druckluft Schrauber

1/2" für Druckluft Schrauber



CODE	R	€/1
134IK11	C	83,00

Der Koffer enthält :

- 14 Spannstifte 1/2" (10-11-12-13-14-15-16-17-18-19-21-22-24-27 mm)
- 3 Verlängerungen (50-150-250 mm)
- 2 Adapter 1/2" F / 3/8" M



ALCHOC740

Bits für Druckluft Bohrer und Schrauber



CODE	R	€/1
134IK24	C	83,00

Der Koffer enthält :

- 10 Spannstifte 1/2" (8-10-11-12-13-14-17-19-21-22 mm)
- 3 PH-1 / PH-2 / PH-3
- 3 PZ-1 / PZ-2 / PZ-3
- 4 Hex 3, 4, 5 et 6 mm
- 4 Bits 3 / 4 / 5 / 6
- 7 Torx TX10 / TX15 / TX20 / TX25 / TX27 / TX30 / TX40
- 7 Torx mit Loch TH10 / TH15 / TH20 / TH25 / TH27 / TH30 / TH40
- 1 Spannstift 1/2" Adapter
- 1 magnetischer Bithalter



ALCHOC325



DRUCKLUFT



Kompressor	62
Zuberhörteile	64



ALAIR 4/25 OILESS



CODE	R	€/1
AL57150	B	210,00

0,166 hp	3,8 L	230V - 50Hz	0,8 Amp	25 l/min	8 bars	5 bars
2840 rpm	0 - 14 bars	yes, oilless	70 dB	L.36-W.33-H.30	13 kg	1

ALAIR 10/200 OILESS



CODE	R	€/1
AL57162	B	350,00

2 hp	10 L	230V - 50Hz	4,9 Amp	198 l/min	8 bars	5 bars
2840 rpm	0 - 14 bars	yes, oilless	84 dB	L.40-W.36-H.75	23 kg	1

ALAIR 20/255



CODE	R	€/1
AL57170	B	530,00

EA028030
(p.58)



2,5 hp	20 L	230V - 50Hz	6,5 Amp	255 l/min	10 bars	8 bars
2840 rpm	0 - 16 bars	no	82 dB	L.65-W.45-H.90	49 kg	2

ALAIR 25/430



CODE	R	€/1
AL57180	B	770,00

EA028030



3 hp	25 L	230V - 50Hz	11 Amp	433 l/min	10 bars	8 bars
2840 rpm	0 - 16 bars	no	81 dB	L.75-W.60-H.90	62 kg	2

ALAIR 60/430



1 phase

CODE	R	€/1
AL57190	B	810,00

3 hp	60 L	230V - 50Hz	11 Amp	433 l/min	10 bars	8 bars
2840 rpm	0 - 16 bars	no	85 dB	L.40-W.50-H.90	60 kg	2

ALAIR 100/430



1 phase

CODE	R	€/1
AL57210	B	870,00

3 hp	100 L	230V - 50Hz	11 Amp	433 l/min	10 bars	8 bars
2840 rpm	0 - 16 bars	no	85 dB	L.120-W.48-H.78	89 kg	2

ALAIR 300/674



3 phase

CODE	R	€/1
AL57220	B	1 190,00

5,5 hp	300 L	400V - 50Hz	674 l/min	10 bars	8 bars	920 rpm
0 - 16 bars	no	L.155-W.59-H.113	133 kg	2		

ALAIR 55



CODE	R	€/1
AL57000	B	1 480,00

EA028030



4,8 hp	25 L	381 l/min	10 bars	8 bars	3600 rpm	16 bars
no	94 dB	L.82-W.55-H.122	51 kg	2	gasoline	

DRUCKLUFT Generator

ALSAGROUPE 7500



CODE	R	€/l
AL65500	B	1 190,00



7,5 kVA	230V - 50Hz	30 A	96 dB	L.70-W.55-H.58	88 kg	2 prises mono
12V - 8,3A	25 L	gazoline	9h	420cc		

DRUCKLUFT Pneumatik-Zubehör

360° DRUCKLUFT SCHLAUCHTROMMEL AUFROLLER 1/4"

360° ; 15 bars ; Temperatur -5 - 60°C ; 30m ; 1/4"
L 340 - w 280 - H 370 - 10 kg



CODE	R	€/l
EA028030	B	153,00

WAND AUFROLLER 1/4"

15 bars ; 15m ; 1/4"
L 400 - W 330 - H 175 - 8 kg



CODE	R	€/l
HR040815	B	248,00

SCHLAUCH PVC

-20 - 65°C ; 0-18 bars



CODE	DESCRIPTION	
TUBPVC08	Schlauch PVC	Ø 8 x 14
TUBPVC13	Schlauch PVC	Ø 13 x 19

SPIRALSCHLAUCH



CODE	DESCRIPTION	
R0804	Spiralschlauch ¼	Ø 6,5 x 10 - 4 m
SPIR10	Spiralschlauch ¼	Ø 6,5 x 12 - 10 m

DRUCKLUFT SCHLAUCH

10m ; 1/4" ; -20 - 65°C ; 0-18 bars.



CODE	DESCRIPTION	R	€/l
TUYAU10	Hochdruckluft-Schlauch mit HP-Anschlüssen	B	56,00

AUSBLAS PISTOLE

1/4" ; 0-12 bars



CODE	DESCRIPTION	R	€/1
ECU93	Ausblas Pistole	B	9,30

FARB PISTOLE

500ml ; 1/4" ; 6 bars



CODE	DESCRIPTION	R	€/1
PAINT145	Farb Pistole	B	67,00

REIFENFÜLLER PISTOLE

0-10 bars



CODE	DESCRIPTION	R	€/1
AG58100	Reifenfüller Pistole	B	26,00

MANOMETER



CODE	DESCRIPTION	R	€/1
A38-26	Manometer allein 0-10 bars - 1/8"	B	26,00
MS41012	Manometer allein 0-12 bars - 1/8"	B	27,00
MS51016	Manometer allein 0-16 bars - 1/4"	B	28,00

GLEICHGEWICHTER



CODE	DESCRIPTION	R	€/1
9302	1-2 kg - 1,60m	B	128,00
9303	2-4 kg - 1,60m	B	139,00
9322	4-6 kg - 2,00m	B	279,00
9323	6-8 kg - 2,00m	B	309,00
08SPI5	Gleichgewichter mit Antriebsschlauch von 2-5 kg - 1,89m - 3/8"	B	330,00

SUPRESSOR

2-10 bars ; 1000 l/min ; 3/8" ; 2 - 50°C ; 4 kg



CODE	DESCRIPTION	R	€/1
031056	Supressor F03	B	1 100,00

DRUCK REGULATOR

0-10 bars ; 1/4" + 3/8" ; 350g ; 5 - 60°C



CODE	DESCRIPTION		R	€/l
R040-01	Druckregulator	1/4"	B	41,00
R050-11	Druckregulator	3/8"	B	41,00

DRUCK REGULATOR MIT FILTER

0-10 bars ; 1/4" + 3/8" ; 500g ; 5 - 60°C ; 5-40µ



CODE	DESCRIPTION		R	€/l
FR040-04	Druckregulator mit Filter	1/4"	B	49,00
FR050-14	Druckregulator mit Filter	3/8"	B	49,00

LUBRIFICATOR

1/4" + 3/8" ; 360g ; 5 - 60°C ; oil HF32



CODE	DESCRIPTION		R	€/l
L040-03	Lubrificator	1/4"	B	31,00
L050-13	Lubrificator	3/8"	B	31,00

FILTER + DRUCK REGLER

0-10 bars ; 1/4" + 3/8" ; 980g ; 5 - 60°C ; 5-40µ



CODE	DESCRIPTION		R	€/l
FR+L1/4	Filter & Druck Regler	1/4"	B	83,00
FR+L3/8	Filter & Druck Regler	3/8"	B	83,00

PNEUMATIK ÖL



CODE	DESCRIPTION		R	€/l
HUILEVAS	Öl 2 L		B	22,00
12BHUILE	Öl 15 ml		B	2,00

ÖL FÜR WÄRMEKRAFTMASCHINE



CODE	DESCRIPTION		R	€/l
MIN15W40	Öl turbo-X 15W-40 2 L		B	20,00

ÖL FÜR ELEKTRISCHEN KOMPRESSOR



CODE	DESCRIPTION		R	€/l
53ML73	Öl für Kompressor stille	500 ml	B	16,00
ML73	Öl für Kolbenkompressor	2 L	B	37,00
125FHUIL	Öl für Kolbenkompressor	500 ml	B	8,30

BAUSTELLEN ÖLER



CODE	DESCRIPTION		R	€/l
LUBAIR	Baustellen Öler	1/4" débit réglable	B	15,50

WEIBLICH



CODE	DESCRIPTION		R	€/1
122644	Schnellverbinder Weiblich 1/4	G/F- Gewinde Weiblich 1/4	C	22,00
S22644	Schnellverbinder Weiblich mit Sicherheit 1/4	G - Gewinde Weiblich 1/4 anti coup de fouet*	C	66,00
142644	Schnellverbinder Weiblich 1/4	St - Gewinde Weiblich 1/4	C	22,00
122633	Schnellverbinder Weiblich 1/4	G - Gewinde Weiblich 3/8	C	22,00
S22633	Schnellverbinder Weiblich mit Sicherheit 1/4	G - Gewinde Weiblich 3/8 anti coup de fouet*	C	66,00
H020902	Schnellverbinder Weiblich 1/4	G/F- Gewinde Weiblich 3/8	C	22,00

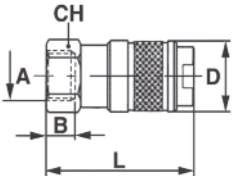

CODE	VERBINDER	Ø TARAUDAGE	TYPE	A	B	CH	D	L
122644	1/4"	1/4"	G - F - UEC	1/4"	11	21	24	55
S22644	1/4"	1/4"	G - MP	1/4"	12	19	26	75
142644	1/4"	1/4"	St - CRP	1/4"	12	19	22	55
122633	1/4"	3/8"	G - F - UEC	3/8"	11,5	21	24	55,5
S22633	1/4"	3/8"	G - MP	3/8"	10	22	26	91
H020902	1/4"	3/8"	G - F - UEC	3/8"	8	19	27,5	50

MÄNNLICH



CODE	DESCRIPTION		R	€/1
121644	Schnellverbinder Weiblich 1/4	G/F- Gewinde Männlich 1/4	C	22,00
S21644	Schnellverbinder Weiblich mit Sicherheit 1/4	G - Gewinde Männlich 1/4 anti coup de fouet*	C	66,00
141644	Schnellverbinder Weiblich 1/4	St - Gewinde Männlich 1/4	C	22,00
121633	Schnellverbinder Weiblich 1/4	G/F- Gewinde Männlich 3/8	C	22,00
S21633	Schnellverbinder Weiblich mit Sicherheit 1/4	G - Gewinde Männlich 3/8 anti coup de fouet*	C	66,00
H020802	Schnellverbinder Weiblich 1/4	G/F- Gewinde Männlich 3/8	C	22,00

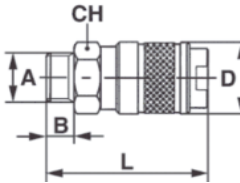

CODE	VERBINDER	Ø DU FILETAGE	TYP DES VERBINDERS	A	B	CH	D	L
121644	1/4"	1/4"	G - F - UEC	1/4"	8	21	24	53
S21644	1/4"	1/4"	G - MP	1/4"	12	19	26	75
141644	1/4"	1/4"	St - CRP	1/4"	8	19	22	52
121633	1/4"	3/8"	G - F - UEC	3/8"	9	21	24	54
S21633	1/4"	3/8"	G - MP	3/8"	9	19	26	75
H020802	1/4"	3/8"	G - F - UEC	3/8"	11	19	27,5	53

SCHLAUCH DRUCKLUFTVERBINDER



CODE	DESCRIPTION		R	€/1
125608	Schnellverbinder Weiblich für Schlauch Ø8	G/F- 1/4	C	22,00
S25608	Schnellverbinder Weiblich für Schlauch/ Sicherheit Ø8	G - 1/4 anti coup de fouet*	C	66,00
145608	Schnellverbinder Weiblich für Schlauch Ø8	St - 1/4	C	22,00
125610	Schnellverbinder Weiblich für Schlauch Ø10	G - 1/4	C	22,00
S25610	Schnellverbinder Weiblich für Schlauch Ø10	G - 1/4	C	66,00
135808	Schnellverbinder Weiblich für Schlauch Ø8	G - 3/8	C	22,00

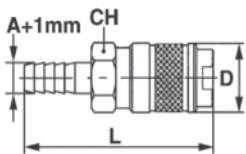

CODE	VERBINDER	Ø DU FILETAGE	TYPE DES VERBINDERS	A	B	CH	D	L
125608	1/4"	8	G - F - UEC	8	-	21	24	64
S25608	1/4"	8	G - MP	8	-	14	26	100
145608	1/4"	8	St - CRP	8	-	19	22	64
125610	1/4"	10	G - F - UEC	10	-	21	24	64
S25610	1/4"	10	G - MP	10	-	15	26	110
135808	3/8"	8	G - MP	8	-	24	28	66

DREHENDER VERBINDER

CODE	DESCRIPTION		R	€/1
TU1014PT	Drehender Verbinder		C	4,00
1010CM38	Drehender Verbinder	mit Feder de guidage	C	21,00

WEIBLICH

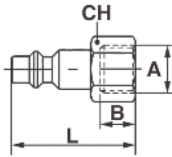

CODE	DESCRIPTION		R	€/1
T023904	Schnellverbinder Männlich 1/4	G - Gewinde Weiblich 1/4	C	8,60
242644	Schnellverbinder Männlich 1/4	St - Gewinde Weiblich 1/4	C	8,60
T023404	Schnellverbinder Männlich 1/4	F - Gewinde Weiblich 1/4	C	8,60
T023905	Schnellverbinder Männlich 1/4	G - Gewinde Weiblich 3/8	C	8,60
232833	Schnellverbinder Männlich 3/8	G - Gewinde Weiblich 3/8	C	8,60
242633	Schnellverbinder Männlich 1/4	St - Gewinde Weiblich 3/8	C	8,60
T023405	Schnellverbinder Männlich 3/8	F - Gewinde Weiblich 3/8	C	8,60

CODE	VERBINDER	Ø SCHLAUCH	TYP	A	B	CH	L
T023904	1/4"	1/4"	G - MP	1/4"	12	17	38
242644	1/4"	1/4"	St	1/4"	11	17	41
T023404	1/4"	1/4"	F - OP	1/4"	12	17	35
T023905	3/8"	3/8"	G - MP	3/8"	12	19	41
232833	3/8"	3/8"	G - MP	3/8"	14	19	40
242633	3/8"	1/4"	St	1/4"	12	19	41
T023405	3/8"	3/8"	F - OP	3/8"	12	19	39

MÄNNLICH

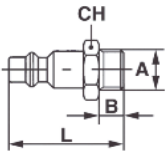

CODE	DESCRIPTION		R	€/1
T023901	Schnellverbinder Männlich 1/4	G - Gewinde Männlich 1/4	C	5,90
241644	Schnellverbinder Männlich 1/4	St - Gewinde Männlich 1/4	C	5,90
T023401	Schnellverbinder Männlich 1/4	F - Gewinde Männlich 1/4	C	5,90
T023902	Schnellverbinder Männlich 1/4	G - Gewinde Männlich 3/8	C	8,60
231833	Schnellverbinder Männlich 3/8	G - Gewinde Männlich 3/8	C	8,60
241633	Schnellverbinder Männlich 1/4	St - Gewinde Männlich 3/8	C	8,60
T023402	Schnellverbinder Männlich 3/8	F - Gewinde Männlich 3/8	C	8,60
3815154	Schnellverbinder Männlich 3/8	St - Gewinde Männlich 3/8	C	23,00

CODE	VERBINDER	Ø TARAUDAGE	TYP	A	B	CH	L
T023901	1/4"	1/4"	G - MP	1/4"	9	14	38
241644	1/4"	1/4"	St	1/4"	9	17	41
T023401	1/4"	1/4"	F - OP	1/4"	9	14	35
T023902	1/4"	3/8"	G - MP	3/8"	11	17	41
231833	3/8"	3/8"	G - MP	3/8"	9	19	40
241633	3/8"	1/4"	St	1/4"	13	17	56
T023402	3/8"	3/8"	F - OP	3/8"	11	17	48
3815154	3/8"	3/8"	St	3/8"	9	19	42

SCHLAUCH DRUCKLUFTVERBINDER

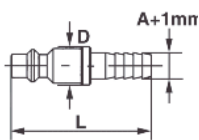

CODE	DESCRIPTION		R	€/1
T024002	Schlauch Verbinder Ø8	G - 1/4	C	7,50
235808	Schlauch Verbinder Ø8	G - 3/8	C	7,50
245608	Schlauch Verbinder Ø8	St - 1/4	C	7,50
T0234019	Schlauch Verbinder Ø8	F - 1/4	C	8,60
235810	Schlauch Verbinder Ø10	G - 3/8	C	8,60

CODE	VERBINDER	Ø SCHLAUCH	TYP	A	D	L
T024002	1/4"	8	G - MP	8	12	48
MP30H	3/8"	8	G - MP	8	12	40
245608	1/4"	8	St	8	12	51
T0234019	1/4"	8	F - OP	8	12	38
235810	3/8"	10	G - MP	10	12	40

TEFLON



CODE	DESCRIPTION		R	€/1
TEFLON	Teflon 12 x 12	-	C	4,20

360°



CODE	DESCRIPTION		R	€/1
RACOR360	Verbinder 360°	2 Gewinde 1/4	C	12,00
RACOR361	Verbinder 360°	1 Gewinde 1/4 et 1 bits G 1/4	C	11,00
RACOR362	Verbinder 360°	2 Gewinde 1/4	C	11,00

MANTELROHR



CODE	DESCRIPTION		R	€/1
304048	Für Schlauch von Ø 8	1/4	C	4,90
304032	Für Schlauch von Ø13	3/8	C	7,50

NIPPEL



CODE	DESCRIPTION		R	€/1
201088	Doppelt Nippel männlich	1/8 männlich x 1/8 männlich	C	3,60
201044	Doppelt Nippel männlich	1/4 männlich x 1/4 männlich	C	4,90
201033	Doppelt Nippel männlich	3/8 männlich x 3/8 männlich	C	4,90
201022	Doppelt Nippel männlich	1/2 männlich x 1/2 männlich	C	5,90

REDUZIERER



CODE	DESCRIPTION		R	€/1
203084	Réduction männlich/männlich	1/8 männlich x 1/4 männlich	C	5,90
203043	Réduction männlich/männlich	1/4 männlich x 3/8 männlich	C	5,90
203042	Réduction männlich/männlich	1/4 männlich x 1/2 männlich	C	5,90
209048	Réduction männlich/weiblich	1/4 männlich x 1/8 weiblich	C	5,90
209034	Réduction männlich/weiblich	3/8 männlich x 1/4 weiblich	C	5,90
209024	Réduction männlich/weiblich	1/2 männlich x 1/4 weiblich	C	5,90
209012	Réduction männlich/weiblich	3/4 männlich x 1/2 weiblich	C	11,00
205048	Réduction weiblich/männlich	1/4 weiblich x 1/8 männlich	C	5,90

VERBINDER



CODE	DESCRIPTION		R	€/1
601044	Verbinder Y	1/4 weiblich	C	9,60
601033	Verbinder Y	3/8 weiblich	C	9,60
400044	Verbinder T	1/4 weiblich	C	9,60
405044	Verbinder T	1/4 weiblich/weiblich/männlich	C	9,60
602044	Kreuz weiblich	1/4 F	C	9,60

HOCHDRUCK VERBINDER



CODE	DESCRIPTION		R	€/1
TT05015	Für Kompressor	1/4 Weiblich	A	33,00
TT05425	Für Nagler	1/4 Männlich	A	69,00
AH70002	Für Schlauch	Weiblich	A	74,00
AH10389	Für Schlauch	Männlich	A	56,00

HOCHDRUCK VERBINDER



CODE	DESCRIPTION		R	€/1
PBS90814	Verbinder Kette	Ø 8 - 14	C	3,30
PBS91320	Verbinder Kette	Ø 13 - 20	C	3,30

HUND		ARROW	ATRO-BOSTITCH	BEA	DEWALT	DUO-FAST	HAUBOLD	HITACHI	HOLZ-HER	KIHLBERG
A	15		80/JK680	80		80	KL800		3404	JK680
AD	15		84/SBNK	384		84				
AK	15		JK 779			68	KL9000			JK779
AR-1	15		AR-1							
B	15		35/A	35		35		35		JK560
BC	16	T20/T25/MT25								
BM	16		SW 9040							
CROCHET ARDOISE	16									
D	16		SB 5019	95		50	KL900		2745/3405	JK64
E	16		90	90		18	KL6000	3004	2750/3423	JK781
EM	17						KL5000		3755	
ES	17									
FB	17		STCR 5019							JK694
G	17		W18							
GB	17						KL500		3424-3413-3761	
GX	18			1310						
H	18		92/SL5035	192						JK664
HB	18		98	98		33				JK689
HR 18	18									
JK 590	18									JK590
K	19		97/SX5035							
L	19		100-S5	14-155			KG7000	5008		JK783
MV	19									
O	19		93	97		34			2747/2748	JK690
P	19		SP 5019							
PB	20									
PF	20	ET50/T50/T55/HT50					KL1100			JK671
PM	20		SB3020	72						
Q	20			170-180		15	HD7900/SD9100			
R	21		32	32		32				JK561
R555	21									JK555
S	21		16NC-S4							
SP	21		SP 1906							JK16
TB	21						KL4000			
TK	21		SJK-SJ3020			SJK				
U	22		74			40				
V	22		7/72	71		3G-30	KL7100			
VF	22						KL1400			
VS	22									JK1
VX	22	JT21/T27/T30								
VZ	22		37							
WC	23		16WC-S2	140						
WD	23						BK2500		3764	
WN 25	23		CF	W		110	WN25		3445-3446	
WN 35	23						WN35		3447	
WP	24						BS29000			
WS	24					17				JK784
Z	24				D51430	76	KG700		3431/32/18/25	

HUND	PAGE	MAKITA	METABO	OMER	PASLODE	PREBENA	ROCAFIX	RAPID	SEINCO	DIVERS
A	15			80	W 130	A	12		80/AT	
AD	15			84		AD				
AK	15			65		AG				
AR-1	15									
B	15				35	B			35	
BC	16						7			
BM	16					BM				
CROCHET ARDOISE	16									
D	16			50	PW	D			5	
E	16	AT638		90		E			L-N4450	
EM	17									
ES	17		TAE 30			ES	14	606		
FB	17			B10		FB				
G	17			SG44		G		44	M-G4450	
GB	17						44			
GX	18				GS 16	GX				
H	18			92	I 870					
HB	18			98		HB				
HR 18	18									
JK 590	18									
K	19					K				
L	19			M1/M2	S106	L			N-G5562	
MV	19									
O	19			4097	N 590	O		137		
P	19				W50	P			J 5	
PB	20				Rapid 73	PB				
PF	20	T 221 DW		T50	Rapid 11	PF	4	11/140	11	
PM	20			64/62		PM	2		B-3	
Q	20			M3					Q-Q6774	
R	21				32				32	
R555	21									
S	21			S4		S				
SP	21									
TB	21						KL4000			
TK	21			SJK		TK				
U	22					U				
V	22			3G	L3G	V			C-G3	
VF	22			68						
VS	22					VS				26
VX	22		TAE 18/19/20		3	VX	1/3	53/15		
VZ	22					VZ		13/19/37		
WC	23			WS		WC				
WD	23									
WN 25	23					WN				
WN 35	23									
WP	24									
WS	24			WP		WS			P-W5562	
Z	24			700		Z				

HUND		ARROW	ATRO-BOSTITCH	BEA	DEWALT	DUO-FAST	HAUBOLD	HITACHI	HOLZ-HER	KIHLBERG
AL	PAGE 41		Mini 0,6/MP6	S062		6	SN06			
BRADS 20°	42				DC618KB					
BE	42		18S/MP8	S700		8				
BR	42		DB/FN15/FN16	SKAM 400						
DA	43			SK - DA	D51275K	DA		NT65AA	3441	
GA	43		I	S100		I	SN10			
JA	43		Minitip	SK 200				MG		
JM	43									
J	44		Tipin/BT 13	SK 300	D51238K	44	SKN12	NT45A	3438/3439/3440	
N	45		Tip/Brads	SK 400	D51256K	60	SKN16	NT65A		
ND	45			SK 500		8	SKN20			
SD	45		AP/SPIN	S400		12				
T	46		TN/N12	T		T	TN22		3419-T	
COILS SHEET	46						RNCW25			
ROOFING	47		ROOFING/CR	554DC		RBW	RNCW30	NV45AB	3519/3520	
COILS BO	47		N203/N57	550 DC		CN 57				
COILS 21	47		ROLL 60	565 DC			RNCW22	NV386NV50		
COILS 23-25-28-31-34	48			700 DC			RNCW25	NV65/NV83A/NV90		
20°	49	KN-RN		R20	D51845	CN350/DFSN90/100	RN	NR83A	3548/40/42/47/50	
34° / Pack	51			D34	D51823	PSN90/PSN100.1			NR83AA	
FAUSSE-VIS	54									
JDB 20°	54						RB25		3554	
ANCRAGE	54		MCN 38	KMR		CNV300J/BS1-PSN50	RN		3521	

HUND	PAGE	MAKITA	METABO	OMER	PASLODE / SPIT	PREBENA	ROCAFIX	RAPID	SEINCO	DIVERS
		AL	41	BPT35ORFE				AL		
BRADS 20°	42				IM6SAF16					
BE	42			PINS8	818	BE				
BR	42			DB16						
DA	43			DA	FN1565A34	DA	32		DA-SFN1	
GA	43			PINS 1	P18	GA	9	9	AZ	
JA	43			BRADS M		JA				
JM	43					JM			AY	
J	44	AF503	TAE3018/19/20	BRADS 12	F18/IM50F18	J	8	8/300	AX	
N	45			BRADS 14	F16/IM65F16	N	16	16	Gauge 16	
ND	45			BRADS 17	F14	ND				
SD	45					SD				
T	46			TN 11		T			T-M2T-M3T	
COILS SHEET	46									
ROOFING	47						SCN50R		3174/45	
COILS BO	47			CNW203						
COILS 21	47			CNW21					SCN 50	
COILS 23-25-28-31-34	48			CNW23					SCN60/65/75	
20°	49						HB 130/HB 160		OUI + 17°	
34° / Pack	51	AN943/GN900SE			IM350/IM90i		D-SFN325/50		Idem Impulse	50
FAUSSE-VIS	54									
JDB 20°	54									
ANCRAGE	54				PPN50i				MC60-34	



SYSTAINER

NEW

SYSTAINER I

Aussen : H 105 - L 400 - I 300 mm. Innen: H 72 - L 377 - I 277 mm. Poids : 1,30 kg.



CODE	R	€/1
80100006	A	68,00

Geeignet für :
- 12/16 P1
- 08/25 PL1
- N-64 P1

SYSTAINER II

Aussen : H 157,50 - L 400 - I 300 mm. Innen : H 124 - L 377 - I 277 mm. Poids : 1,50 kg.



CODE	R	€/1
80100007	A	73,00

Geeignet für :
- 10/40 P2
- 10/50 P2
- PN-C2

SYSTAINER III

Aussen : H 210 - L 400 - I 300 mm. Innen : H 176 - L 375 - I 274 mm. Poids : 1,90 kg.



CODE	R	€/1
80100008	A	79,00

Geeignet für :
- 24/38 P1
- AP 50 Alu

SYSTAINER IV

Aussen : H 315 - L 400 - I 300 mm. Innen : H 281 - L 360 - I 272 mm. Poids : 2,10 kg.



CODE	R	€/1
80100009	A	84,00

Geeignet für :
- C 23/55 P1
- C 41/65 P1
- 2 Geräte Panasonic

SYSTAINER V

Aussen : H 420 - L 400 - I 300 mm. Innen : H 395 - L 360 - I 272 mm. Poids : 3,10 kg.



CODE	R	€/1
80100010	A	92,00

Geeignet für :
- 2 oder 3 Geräte Panasonic
- Panasonic Geräte

ZUBEHÖR FÜR SYSTAINER

CODE	DESCRIPTION	R	€/1
447338	Abdeckplatte zum Schutz	A	6,00
544618	Schaumstoff-Platte von 50 mm ganz Modular	A	27,00